



MEDASTE

VOTRE APPRENTISSAGE, NOTRE DEVOIR



medastepro@gmail.com

SPINA INSTRUMENT



Email:
medastepro@gmail.com



MEDASTE



MEDASTE

VOTRE APPRENTISSAGE, NOTRE DEVOIR

MEDASTE

LAMINECTOMY

Kerrison Laminectomy Punch



90°



90°

90° UPWARD JAW

18cm/7" Shaft 20cm/8" Shaft Bite Size

MS 9071	MS 9081	1mm
MS 9072	MS 9082	2mm
MS 9073	MS 9083	3mm
MS 9074	MS 9084	4mm
MS 9075	MS 9085	5mm
MS 9076	MS 9086	6mm

90° DOWNWARD JAW

18cm/7" Shaft 20cm/8" Shaft Bite Size

MS 9071	MS 9081	1mm
MS 9072	MS 9082	2mm
MS 9073	MS 9083	3mm
MS 9074	MS 9084	4mm
MS 9075	MS 9085	5mm
MS 9076	MS 9086	6mm

Kerrison Laminectomy Punch

- 40° DOWNWARD jaw angle

40° DOWNWARD JAW

18cm/7" Shaft 20cm/8" Shaft Bite Size

MS 4071	MS 4081	1mm
MS 4072E	MS 4082E	2mm
MS 4073E	MS 4083E	3mm
MS 4074E	MS 4084E	4mm
MS 4075E	MS 4085E	5mm
MS 4076E	MS 4086E	6mm



40° DOWNWARD



LAMINECTOMY

'Black Line' Kerrison Laminectomy Punch

- 40° UPWARD jaw angle
- With special titanium coating on surface
- Bone ejector



40° UPWARD JAW

18cm/7" Shaft	20cm/8" Shaft	23cm/9" Shaft	Bite Size
MS 4071 Ti	MS 4081 Ti	MS4091 Ti	1mm*
MS 4072 ETi	MS 4082 ETi	MS 4092 ETi	2mm
MS 4073 ETi	MS 4083 ETi	MS 4093 ETi	3mm
MS 4074 ETi	MS4084 ETi	MS 4094 ETi	4mm
MS 4075 ETi	MS 4085 ETi	MS 4095 ETi	5mm
MS 4076 ETi	MS 4086 ETi	MS 4096 ETi	6mm



40° UPWARD

*1mm size not available with Bone Ejector

Kerrison Laminectomy Punch with Bone Ejector

- 40° UPWARD jaw angle
- Bone ejector



40° UPWARD JAW

18cm/7" Shaft	20cm/8" Shaft	23cm/9" Shaft	Bite Size
MS 4071	MS 4081	MS 4091	1mm*
MS 4072E	MS 4082E	MS 4092E	2mm
MS 4073E	MS 4083E	MS 4093E	3mm
MS 4074E	MS 4084E	MS 4094E	4mm
MS 4075E	MS 4085E	MS 4095E	5mm
MS 4076E	MS 4086E	MS 4096E	6mm



40° UPWARD

*1mm size not available with Bone Ejector

LAMINECTOMY

Thin Footplate Kerrison Laminectomy Punch

- 40° UPWARD jaw angle

40° UPWARD JAW		
18cm/7" Shaft	20cm/8" Shaft	Bite
MS 4071T	MS 4081T	1mm
MS 4072T	MS 4082T	2mm
MS 4073T	MS 4083T	3mm
MS 4074T	MS 4084T	4mm
MS 4075T	MS 4085T	5mm
MS 4076T	MS 4086T	6mm



- A reduced footplate thickness useful for a restricted operating area

40°
UPWARD

Wide Opening Kerrison Laminectomy Punch

- 40° UPWARD jaw angle

40° UPWARD JAW	
20cm/8" Shaft	Bite
MS 4081 Ti	1mm*
MS 4082 ETi	2mm
MS 4083 ETi	3mm
MS 4084 ETi	4mm
MS 4085 ETi	5mm
MS 4086 ETi	6mm

- Wide opening jaws allowing the surgeon to envelope more bone

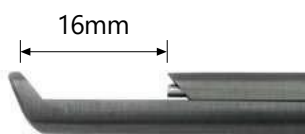

40° UPWARD

*1mm not available with bone ejector

LAMINECTOMY

Titanium Kerrison Dismantable Punch

- 40° UPWARD jaw angle
- Titanium coating
- Take apart for cleaning
- Bone ejector

Press here to open



40° UPWARD JAW			
18cm/7" Shaft	20cm/8" Shaft	23cm/9" Shaft	Bite Size
MS 4071 DTi	MS 4081 DTi	MS 4091 DTi	1mm
MS 4072 DETi	MS 4082 DETi	MS 4092 DETi	2mm
MS 4073 DETi	MS 4083 DETi	MS 4093 DETi	3mm
MS 4074 DETi	MS 4084 DETi	MS 4094 DETi	4mm
MS 4075 DETi	MS 4085 DETi	MS 4095 DETi	5mm
MS 4076 DETi	MS 4086 DETi	MS 4096 DETi	6mm



40° UPWARD

Curved Foramenotomy Punch

- 40° UPWARD jaw angle
- Curved shaft designed to improve access to the



20cm/8" Shaft	Bite
MS 4082	2m
MS 4083	m
MS 4084	3m



LAMINECTOMY

Long Anterior Kerrison Laminectomy Punch

- 40° UPWARD jaw angle
- With special titanium coating on surface
- Extra-long shaft for thoracic approach
- Bone ejector

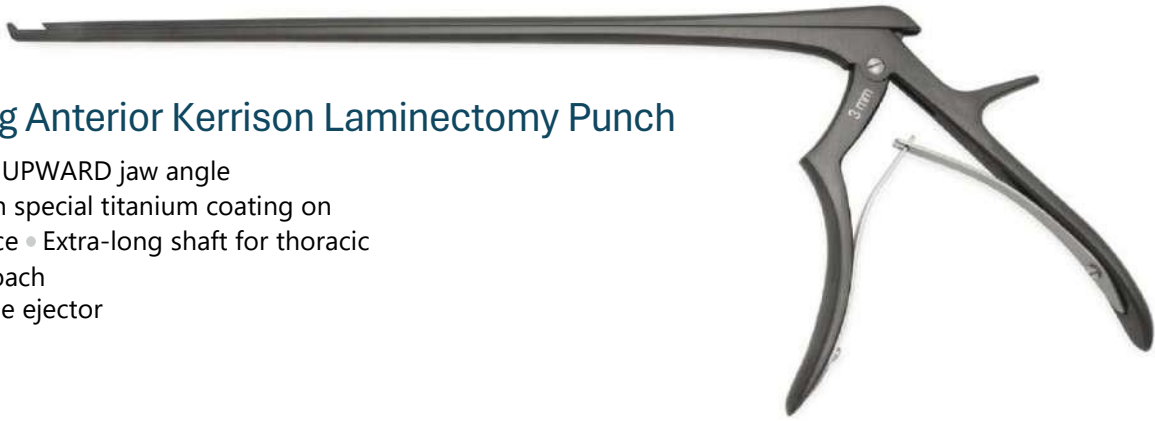

40° UPWARD JAW

28cm/11" Shaft Bite Size

MS 4001Ti	1mm*
MS 4002ETi	2mm
MS 4003ETi	3mm
MS 4004ETi	4mm
MS 4005ETi	5mm
MS 4006ETi	6mm



40° UPWARD

*1mm not available with bone ejector

working length



Bayonet Kerrison

- Punch 40° UPWARD
- jaw angle Allows
- improved visibility
- With special titanium coating on surface
- Bone ejector

40° UPWARD JAW

20cm/7 3/4" Shaft Size working length	23cm/9" Shaft working length	28cm/11" Shaft working length	Bite
12cm/4 3/4"	18cm/7"	20cm/7 3/4"	

MS 4081BTi	MS 4091BTi	MS 4001BTi	1mm
MS 4082BETi	MS 4092BETi	MS 4002BETi	2mm
MS 4083BETi	MS 4093BETi	MS 4003BETi	3mm
MS 4084BETi	MS 4094BETi	MS 4004BETi	4mm
MS 4085BETi	MS 4095BETi	MS 4005BETi	5mm

LAMINECTOMY

Ferris-Smith Kerrison Laminectomy Punch

- 40° UPWARD jaw angle
- Modified ring handle

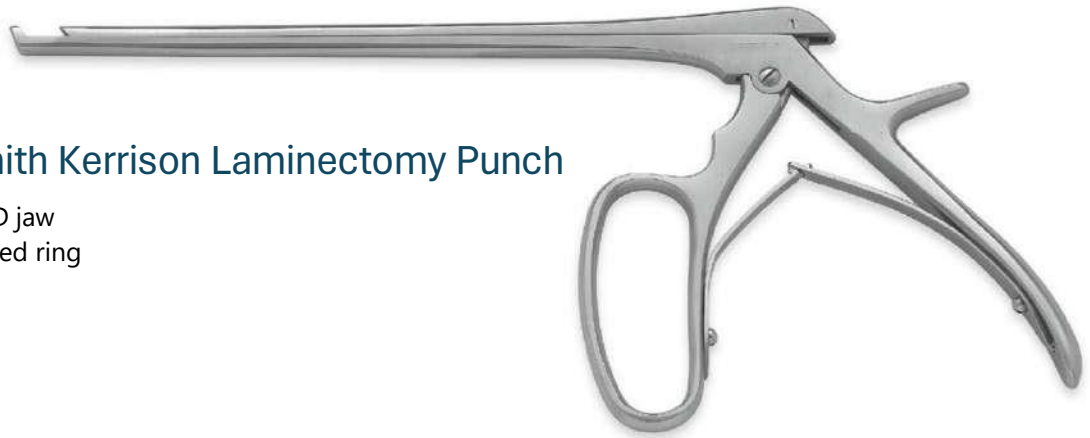

40° UPWARD JAW

18cm/7" Shaft 20cm/8" Shaft Bite Size

MS 4072	MS 4082	2mm
MS 4073	MS 4083	3mm
MS 4074	MS 4084	4mm
MS 4075	MS 4085	5mm
MS 4076	MS 4086	6mm



40° UPWARD

MEDDATA

DISC

Intervertebral Disc Rongeur

STRAIGHT JAW

15cm/6" Shaft	18cm/7" Shaft	20cm/8" Shaft	Bite Size
F6-S	F7-S	F8-S	1mm
K6-S	K7-S	K8-S	1.5mm
C6-S	C7-S	C8-S	2mm
LG6-S	LG7-S	LG8-S	3mm
S6-S	S7-S	S8-S	4mm
R6-S	R7-S	R8-S	5mm
P6-S	P7-S	P8-S	6mm
Q6-S	Q7-S	Q8-S	7mm

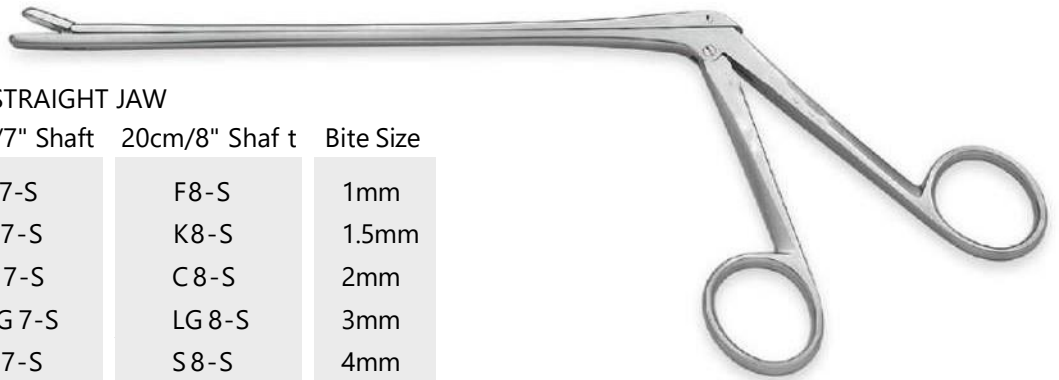

Intervertebral Disc Rongeur

40° ANGLED UPWARD JAW

15cm/6" Shaft	18cm/7" Shaft	20cm/8" Shaft	Bite Size
F6-U	F7-U	F8-U	1mm
K6-U	K7-U	K8-U	1.5mm
C6-U	C7-U	C8-U	2mm
LG6-U	LG7-U	LG8-U	3mm
S6-U	S7-U	S8-U	4mm
R6-U	R7-U	R8-U	5mm
P6-U	P7-U	P8-U	6mm
Q6-U	Q7-U	Q8-U	7mm



Intervertebral Disc Rongeur

40° ANGLED DOWNWARD JAW

15cm/6" Shaft	18cm/7" Shaft	20cm/8" Shaft	Bite Size
F6-D	F7-D	F8-D	1mm
K6-D	K7-D	K8-D	1.5mm
C6-D	C7-D	C8-D	2mm
LG6-D	LG7-D	LG8-D	3mm
S6-D	S7-D	S8-D	4mm
R6-D	R7-D	R8-D	5mm
P6-D	P7-D	P8-D	6mm
Q6-D	Q7-D	Q8-D	7mm



DISC

Caspar Toothed Disc Rongeur

- Serrated and fenestrated jaws

STRAIGHT JAW

16cm/6 1/4" Shaft	18cm/7" Shaft	Bite Size
MS1502 -16	MS1502 -18	2mm
MS1503 -16	MS1503 -18	3mm
MS1504 -16	MS1504 -18	4mm
MS1505 -16	MS1505 -18	5mm

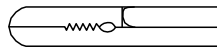

UPWARD JAW

16cm/6 1/4" Shaft	18cm/7" Shaft	Bite Size
MS1602 -16	MS1602 -18	2mm
MS1603 -16	MS1603 -18	3mm
MS1604 -16	MS1604 -18	4mm
MS1605 -16	MS1605 -18	5mm



DOWNWARD JAW

16cm/6 1/4" Shaft	18cm/7" Shaft	Bite Size
MS1702 -16	MS1702 -18	2mm
MS1703 -16	MS1703 -18	3mm
MS1704 -16	MS1704 -18	4mm
MS1705 -16	MS1705 -18	5mm

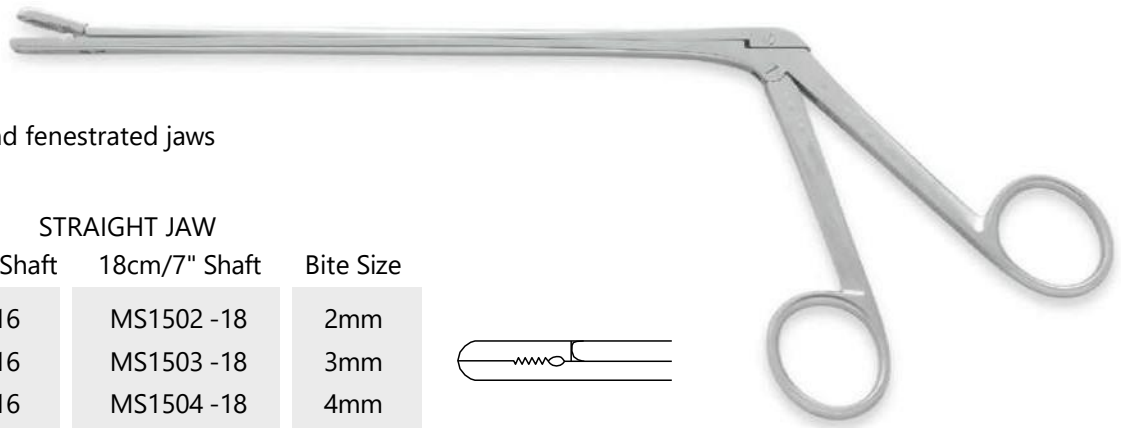
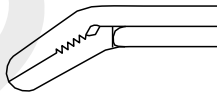

Schlesinger Toothed Rongeur

- Fine serration on the jaw edge

STRAIGHT JAW

15cm/6" Shaft	18cm/7" Shaft	Bite Size
MS1210 -15	MS1210 -18	2mm
MS1310 -15	MS1310 -18	3mm
MS1410 -15	MS1410 -18	4mm

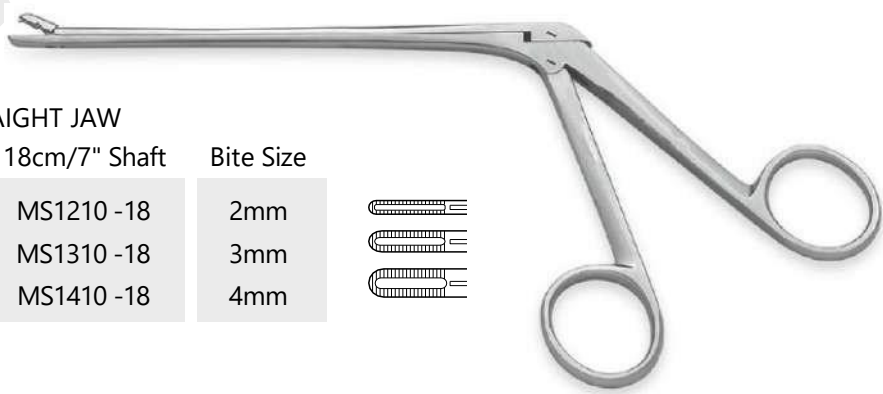
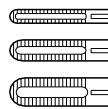

DISC

Williams Discectomy Rongeur

- 14cm/5 1/2" shaft length

MS1110 -14



Single toothed cup 1mm bite

Williams Discectomy Rongeur longer pattern

- 23cm/9" shaft length

MS1110 -23



'Pea Pod' Disc Rongeur

- Short 10mm length jaw

15cm/6" Bite Size

MS1510 -15 2mm

MS1610 -15 3mm

MS1710 -15 4mm

13cm/5 1/4" Bite Size

MS1510 -13 2mm



Extra fine pattern 5mm length jaws

Beck Disc Rongeur

- 13cm/5 1/4" shaft length
- 2mm bite size

MS1910 -13



DISC

- 18cm/7" shaft
- length 1x2 teeth
- Straight iaw

MS1224 -18



Toothed serrated

Munich Grasping Forceps

Weil-Blakesley Forceps

- 18cm/7" shaft length
- Fenestrated jaw

Straight
Jaw

Bite Size

MS1825 -18	2.5mm
MS1830 -18	3.0mm
MS1835 -18	3.5mm



Upward 30°
Angled Jaw

Bite Size

MS1925 -18	2.5m
MS1930 -18	m
MS1935 -18	3.0m



Decker Rongeur

- 15cm/6" shaft
- length Straight iaw

MS1223 -15



2mm jaw

Nicola Micro Cupped Biopsy Forceps

- 16.5cm/6 1/2" shaft length

MS1222 -16

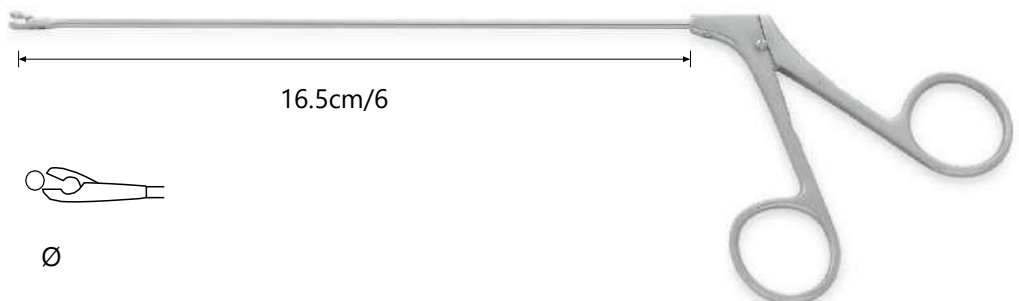

16.5cm/6



∅

DISC

Micro Disc Rongeur

- 17cm/6 ¾" shaft
- length 2mm bite size
- Black titanium coating
- Very slim shaft



Straight jaw
MS1331-17

40° Upward
jaw

Micro Toothed Disc Rongeur

- 17cm/6 ¾" shaft
- length 2mm micro
- toothed jaw Black
- titanium coating Very
- slim shaft



40° Upward jaw
MS1335 -17

Cushing Disc Rongeur

- 17cm/6 ¾" shaft
- length 2mm x 10mm
- short jaw Black



40° Upward
jaw

Toothed Fine Disc Rongeur

- 17cm/6 ¾" shaft length
- 2mm fine toothed jaw
- Black titanium coating



Straight jaw
MS1333 -17

DISC

Ferris-Smith Disc Rongeur

- Ring handle

Straight Jaw

18cm/7" Shaft	20cm/ 8" Shaft	Bite Size
MS 0072	MS 0082	2mm
MS 0073	MS 0083	3mm
MS 0074	MS 0084	4mm
MS 0075	MS 0085	5mm

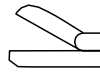

40° Upward Jaw

18cm/7" Shaft	20cm/ 8" Shaft	Bite Size
MS 0072	MS 0082	2mm
MS 0073	MS 0083	3mm
MS 0074	MS 0084	4mm
MS 0075	MS 0085	5mm

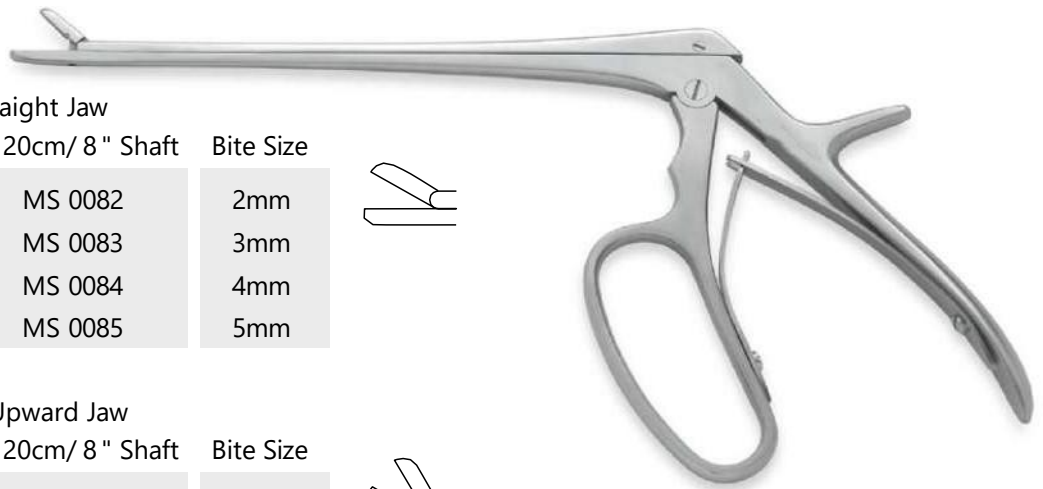
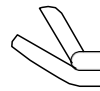

Anterior Disc Rongeur

- 28cm/11" shaft length
- Longer 28cm shaft for greater reach in the anterior approach

Straight	Upward	Bite
MS S- 2	MS U- 2	2mm
MS S- 3	MS U- 3	3mm
MS S- 4	MS U- 4	4mm
MS S- 5	MS U- 5	5mm



Anterior Disc Rongeur

- 35cm/13 1/2" shaft length
- Extra-long length shaft for deeper areas

Straight	Upward	Bite
MS7390-52	-	2.4mm
MS7390-54	MS7390-84	4mm
MS7390-56	-	6mm
MS7390-58	MS7390-88	8mm

with
teeth

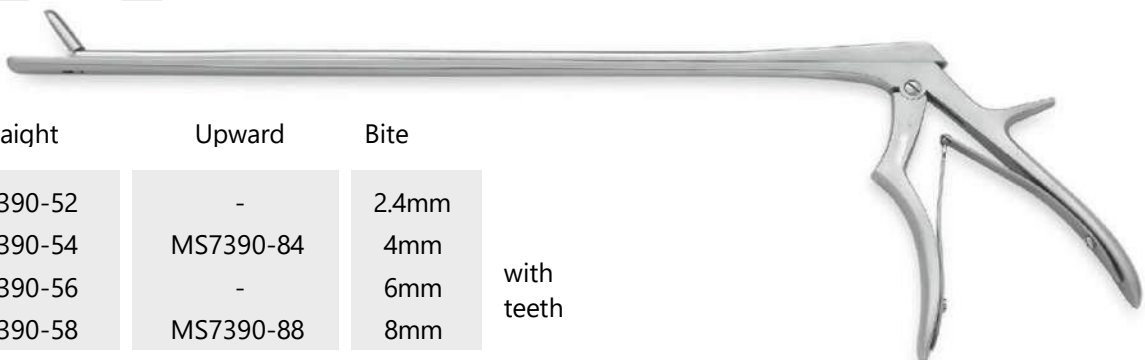

BONE

Lempert Bone Nibbler

- 19cm/7 1/2" length
- Single action

3mm Bite
MS1001-19



Luer Bone Nibbler

- 18cm/7" length
- Single action

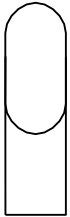

Straight
8mm
Bite

MS1004 -18

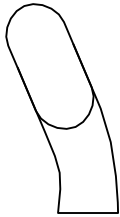

Curved
8mm
Bite

MS1005 -18



Adson Bone Nibbler

- 20cm/8" length
- Single action

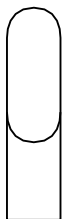

7mm Bite
MS1040-20



BONE

Pennybacker Bone Nibbler

- 20cm/8" length • Single action



4mm Bite
MS1041-20



Northields Bone Nibbler

- 20cm/8" length • Single action

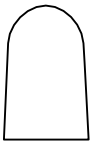

10mm Bite
MS1042-20



'Rat Toothed' Bone Nibbler

- 21cm/8 1/4" length • Single action

5mm Bite
MS1035 -21

8mm Bite
MS1030-21

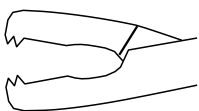

3 x 3 Teeth



3 x 3 Teeth



BONE

Zielke Intervertebral Rongeur

- Angled parallel jaws



21cm/8 1/4" 25cm/9 3/4" Bite Size

MS1026-21

MS1026-25

3mm

MS1027-21

MS1027-25

5mm

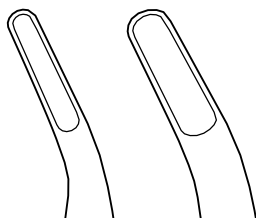

3mm Bite 5mm Bite

Matzen Intervertebral Rongeur

- 20cm/8" length
- Angled jaws



8mm Bite

MS1043-20

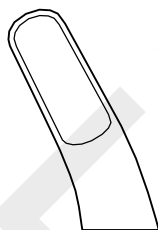

Beyer Bone Nibbler

- 18cm/7" length
- Curved double action



4mm Bite

MS1002 -18



BONE

Jansen Bone Nibbler

- 18cm/7" length
- Curved double action



5mm Bite
MS1003 -18

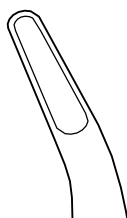

Marquardt Bone Nibble

- 20cm/8" length
- Curved double action



3mm Bite
MS1002-20

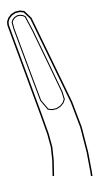

Smith-Peterson Bone Nibbler

- 24cm/9 1/2" length
- Double action



Straight	Light Curve	Bite Size
MS1010-24	SP101 4-24	3mm
MS1011-24	SP101 5-24	4mm
MS1012-24	SP101 6-24	5mm
MS1013-24	SP1017 -24	6mm

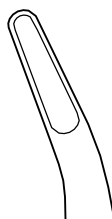

Straight

Light Curve

BONE

Leksell Bone Nibbler

- 24cm/9 1/2" length
- Double action angled



Angled Jaw	Bite Size
MS1018 -24	3mm
MS1019 -24	5mm
MS1020 -24	8mm

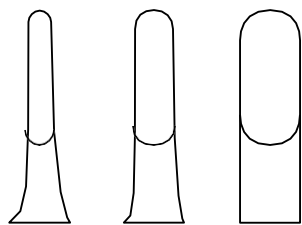

3mm 5mm 8mm

Stille-Luer Bone Nibbler

- 22cm/8 3/4" length
- Double action

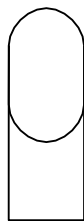

Straight
10mm
Bite
MS1006-22



Curved
10mm Bite
MS1007-2

'Mr Blobby' Stille-Luer Bone Nibbler

- 26cm/10 1/4" length
- Double action

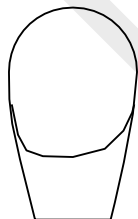

Straight
17mm
Bite
MS1008-26



Curved
17mm Bite
MS1009-26

BONE NIBBLERS

Echlin Duckbill Nibbler

- 23cm/9" length
- Double action

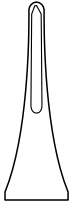

2mm Bite
MS1044-23



3mm Bite
MS1045-23

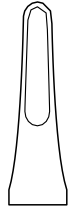

4mm Bite
MS1046-23

Long Anterior Leksell Bone Nibbler

- 30cm/12" length
- Double action

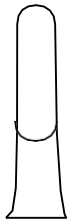

5mm Bite
MS1021-30

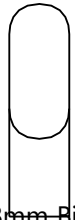

8mm Bite
MS1022-30

Sypert Bone Nibbler

- 36cm/14 1/4" length
- Double action - very long

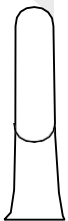

5mm Bite
MS1031-36

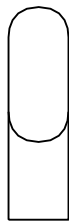

8mm Bite
MS1032-36

BONE CUTTERS

McIndoe Bone Cutters

- 18cm/7" length
- Double action
- Angled jaws



MS1028 -18

Stille-Liston Bone Cutters



Straight

MS1024-27



Angled

MS1025-27



Liston-Key-Horsley Bone Cutters



MS1023-27



Tudor Edwards/Vehmehren Costotome

- 24cm/9 1/2" length
- For cutting ribs

MS1023-24



OSTEOTOMES

Capener Osteotome

• 25cm/9 ¾"
length • Tufnol
handl



Width

MS7210-25	10mm
MS7212-25	12mm
MS7215-25	15mm
MS7220-25	20mm
MS7225-25	25mm
MS7230-25	30mm

Lexer Osteotome • 22cm/8 ½" lengt

Width

MS7207 -22	7mm
MS7210 -22	10mm
MS7215 -22	15mm
MS7220 -22	20mm
MS7225 -22	25mm



Dahmen Osteotome

- 30cm/12" length
- Tufnol handle

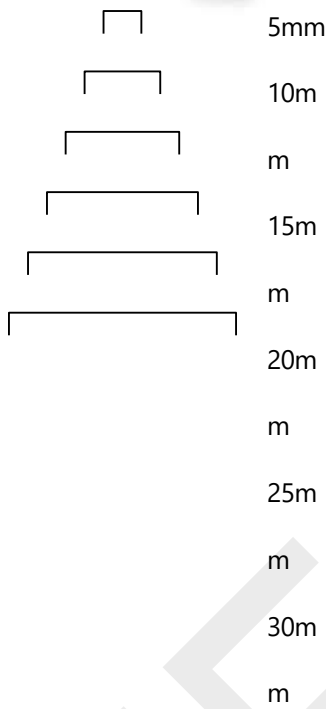

Straight		Angled		Width
MS7105 -30	5mm	MS7305 -30	5mm	5mm
MS7110 -30	10mm	MS7310 -30	10mm	10mm
MS7115 -30	15mm	MS7315 -30	15mm	15mm
MS7120 -30	20mm	MS7320 -30	20mm	20mm
MS7125 -30	25mm	MS7325 -30	25mm	25mm
MS7130 -30	30mm	MS7330 -30	30mm	30mm

Website:
www.medicainstruments.com

OSTEOTOMES

Scaglietti Straight Osteotome Set

MS7452-00



Complete set consisting of:

Qty	Order Code	Description
5		Scaglietti Osteotomes - 5 sizes
1	MS7452-52	Instrument Case

Scaglietti Osteotomes

- 28cm/11" length



Straight	Size
MS7452-06	6mm
MS7452-09	9mm
MS7452-12	12mm
MS7452-16	16mm
MS7452-19	19mm

Lambotte Osteotome



25cm/9 3/4" length
Straight

23cm/9" length
Curved

Widt
h

Widt
h

MS7970 -04	4mm	MS7971-04	4mm
MS7970 -06	6mm	MS7971-06	6mm
MS7970 -08	8mm	MS7971-08	8mm
MS7970 -10	10mm	MS7971-10	10mm
MS7970 -13	13mm	MS7971-13	13mm
MS7970 -16	16mm	MS7971-16	16mm
MS7970 -18	18mm	MS7971-18	18mm
MS7970 -20	20mm	MS7971-20	20mm
MS7970 -25	25mm	MS7971-25	25mm
MS7970 -30	30mm	MS7971-30	30mm

OSTEOTOMES

Mini-Stillé Osteotome

- 16cm/6 1/4" length



Straight

MS7704 -16	4mm
MS7706 -16	6mm
MS7708 -16	8mm

Stillé (Swedish) Osteotome

- 20cm/8" length

Straight

MS7706-20	6mm
MS7708-20	8mm
MS7710-20	10mm
MS7712-20	12mm
MS7715-20	15mm
MS7720-20	20mm
MS7725-20	25mm
MS7730-20	30mm



Hibbs Osteotome with thin blade

- 20cm/8" length
- Extra thin blade



Straight

	Width
MS7804 -20	4mm
MS7806 -20	6mm
MS7808 -20	8mm
MS7810 -20	10mm
MS7812 -20	12mm
MS7815 -20	15mm
MS7820 -20	20mm
MS7825 -20	25mm
MS7830 -20	30mm

Curved

Width

MS7904 -20	4mm
MS7906 -20	6mm
MS7908 -20	8mm
MS7910 -20	10mm
MS7912 -20	12mm
MS7915 -20	15mm
MS7920 -20	20mm
MS7925 -20	25mm
MS7930 -20	30mm

Smith Petersen Osteotome

- 20cm/8" length

Width

MS7610 -20	10mm
MS7615 -20	15mm
MS7620 -20	20mm
MS7625 -20	25mm
MS7630 -20	30mm



MALLETS

Toffee Mallet

- 19cm/7 ½" length
- Head size 22mm Ø
- Weight 165g/6oz



MS5808-21

Ultra Fine Mallet

- 17cm/6 ¾" length
- Head size 20mm Ø
- Weight 145g/5oz



MS5801-17

Heath Mallet

- 19cm/7" length
- Stainless steel head
- Head size 40mm Ø
- Weight 1020g/36oz



MS5809 -19

Mallet with Tufnol Handle

- 23cm/9" length
- Small head size 30mm Ø
- Weight 350g/12oz

MS5803 -23

- Medium head size 35mm Ø
- Weight 550g/20oz

MS5804-23

- Large head size 40mm Ø
- Weight 700g/25oz

MS5805 -23



MALLETS

London Splint Mallet

- 18cm/7" length
- Head size 30mm Ø
- Weight 450g/16.2oz

MS5802 -18



Ombredanne Mallet

- 24cm/9 1/2" length
- Head size 40mm Ø
- Weight 550g/20oz

MS5806 -24



Mallet with Tufnol H

- 24cm/9 1/2" length
- Lead filled head
- Weight 400g/14oz

MS5810-24



Tufnol Mallet

- 25.5cm/10" length
- Head size 42mm Ø
- Weight 250g/10oz

MS5807 -25



COBB ELEVATORS

Cobb Spinal Elevator

- 31cm/12 1/4" overall length
- 18cm/7" handle length



10mm

MS7561-10

13mm

MS7561-13

19mm

MS7561-19

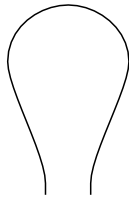
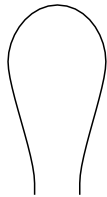

Harrington Cobb Spinal Elevator

- 30.5cm/12" overall length



10mm

MS7661-10

13mm

MS7661-13

19mm

MS7661-19



Cobb Spinal Elevator Extra Long Handle

- 34cm/13 1/2" overall length
- length • 22cm/8 3/4"



handle length

10mm

MS7662 -10



15mm

MS7662-15



20mm

MS7662 -20

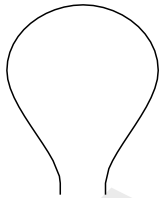

25mm

MS7662 -25

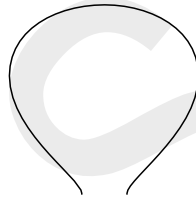

30mm

MS7662 -30

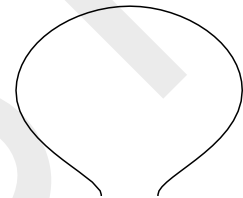

MEDICAL

COBB ELEVATORS

Comfort Cobb
Elevator • 32cm/12 ½"



overall length • 20cm/8"
handle length

10mm
MS7551-10

15mm
MS7551-15

20mm
MS7551-20

25mm
MS7551-25

30mm
MS7551-30

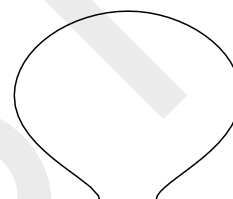
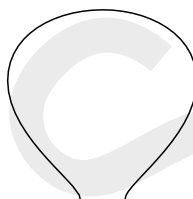
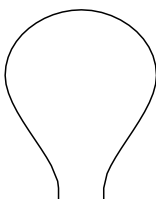

Karl Cobb Elevator

• 32.5cm/12 ¾" overall length
length • 20cm/8" handle



length

10mm
MS7553-10

15mm
MS7553-15

20mm
MS7553-20

25mm
MS7553-25

30mm
MS7553-30

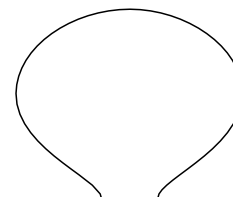
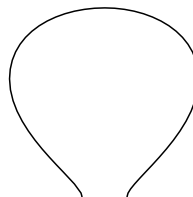
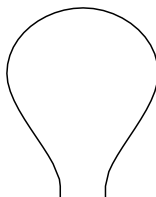

Long Anterior Comfort Cobb Elevator

• 47cm/18 1/4" overall length



10mm
MS7551-50

15mm
MS7551-55

20mm
MS7551-60

25mm
MS7551-65

30mm
MS7551-70

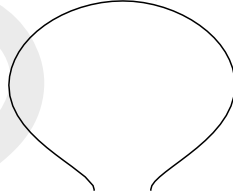
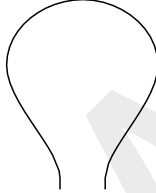
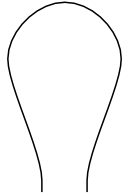

MEDIA

ELEVATORS

Adson Periosteal Elevator

- 16cm/6 ¼" length
- Curved blunt

	Width
MS3055 -16	5mm
MS3007-16	7mm



Pennybacker Periosteal Elevator

- 16cm/6 ¼" length
- Curved sharp

	Width
MS3064 -16	4mm
MS3066 -16	6mm
MS3068 -16	8mm



Bone Raspatory with Tufnol Handle

- 19cm/7 ½" length

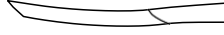
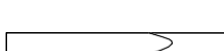

Straight	Width	
MS7016 -19	6mm	
		

Curved	Width	
MS7023 -19	3m	
MS7026 -19	m	

Farabeuf Rugine Elevator

- 15cm/6" length

Straight	Width
MS3001-15	12mm

Curved*	Width
MS3002 -15	12mm



*illustrated

Farabeuf Rugine Elevator with Hollow Handle

- 16cm/6 ¼" length

Straight	Width
MS3011-16	12mm

Curved*	Width
MS3012 -16	12mm



*illustrated

MEDASTYLE

ELEVATORS & GOUGES

Trethowan Bone Elevator

- 22.5cm/8 ½" length



MS3030 -22

Bristow Periosteal Elevator

- 23cm/9" length
- Curved sharp
- 10mm width



MS3003-23

Zielke S-Shaped Gouge

- 23cm/9" length



*illustrated

Curved*	Width	S-Shaped	Width
MS6520 -23	6mm	MS6522 -23	6mm
MS6521 -23	9mm	MS6523 -23	9mm



Capener Lamina Gouge

- 23cm/9" length
- Cranked shaft



	Width
MS6506-23	6mm
MS6508-23	8mm
MS6511-23	11mm
MS6516-23	16mm

DISSECTORS

Swedish Dissector

- 18cm/7" overall length



MS9201 -18

Howarth Elevator

- 21.5cm/8 ½" overall length



MS9207-21

MacDonald Elevator/Dissector



Size

MS7105 -19

18cm/7"

MS9206-23

23cm/9"

Watson Cheyne Dissector



Size

MS7203 -18

18cm/7"

MS9203-23

23cm/9"

MS9203-25

25.5cm/10"

Freers Elevator/Dissector

- 18.5cm/7 ¼" overall length



MS7602 -18

BONE GRAFT IMPACTORS

Cervical Bone Graft Impactor 90° Offset

- 22cm/8 1/2" length



6mm x 12mm
Tip

MS7222-10

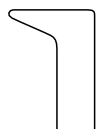

3.5mm x 6mm Tip

MS7222-55

18cm length



Lumbar Bone Graft Impactor

- 22cm/8 1/2" length



7mm x
12mm

MS7222-40

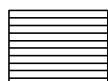

10mm x 13mm

MS7222-50



Anterior Bone Graft Impactor

- 34cm/13 1/2" length



9 x 16mm

Tip

MS7439-48

9 x 23mm Tip

MS7439-50

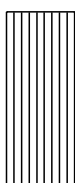
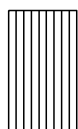

Caspar Bone Gr

- 21.8cm/8 1/4" length



6 x 12mm
Tip

MS6023-21

Dowel holder for taking
larger block grafts and for
vertebral body replacement

MEDASTEEL

BAYONET CERVICAL MICRO CURETTES

Cervical Micro Discectomy Curette Set

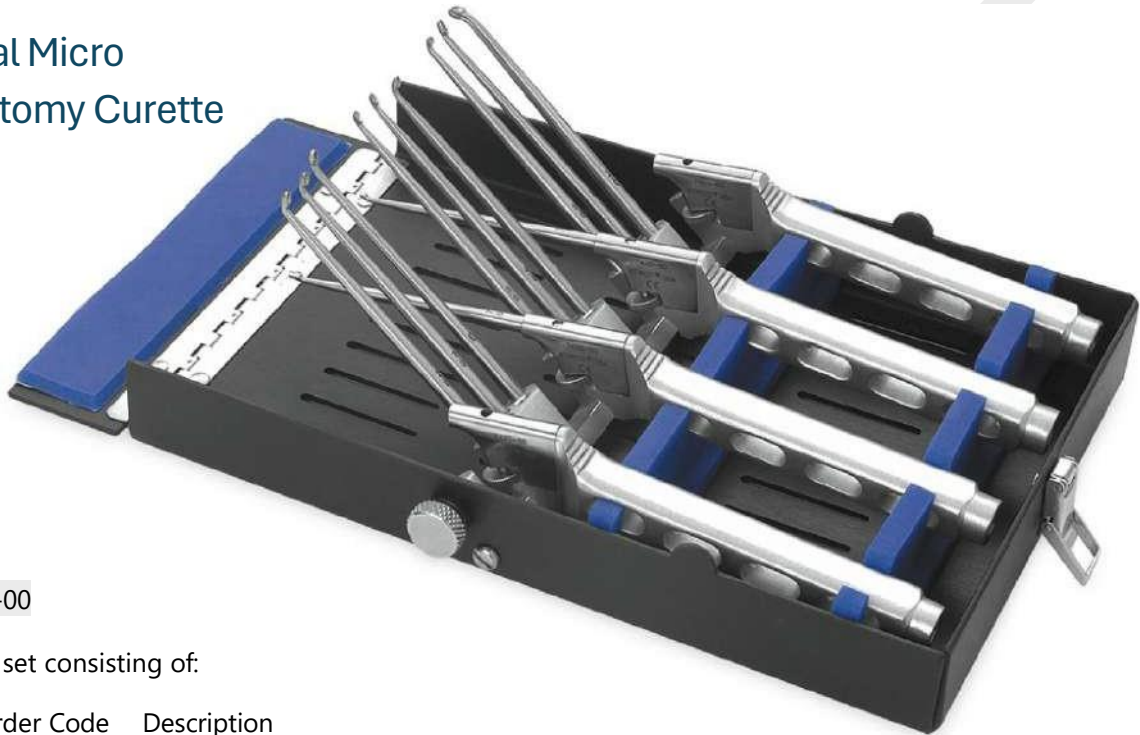

MS7420-00

Complete set consisting of:

Qty	Order Code	Description
4	MS7420-80	Curette Handles
12		Cervical Curette Shafts - includes: 5 Straight Shafts/5 Angled Shafts/2 Down Pushing Shafts
1	MS7420 -90	Sterilising Case



- Bayonet handled design for improved
- visualisation 360° rotating shafts are interchangeable
- Shaft length is adjustable
- Lightweight handle
- Instrument length: 23cm max. for standard
- curettes Shaft length 10cm

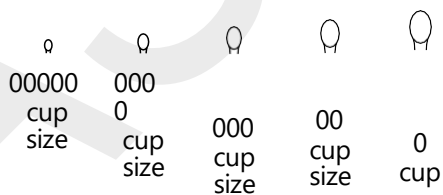

Straight Cup Size

Cup

Forward Angle Size

Cup

Down Pushing

Cup Size

MS7420-50

00000

MS7422-50

00000

MS7424-20

00

MS7420-40

0000

MS7422-40

0000

MS7424-10

0

MS7420-30

000

MS7422-30

000

MS7420-20

00

MS7422-20

00

MS7420-10

0

MS7422-10

0

BAYONET CERVICAL MICRO CURETTES



Bayonet Cervical Curette

- 24cm/9 1/2" overall length
- 12cm/4 3/4" shaft length

Ø	Ø	Ø	Ø	Ø
0000	000	00	0	1
cup size	cup size	cup size	cup size	bone cutter

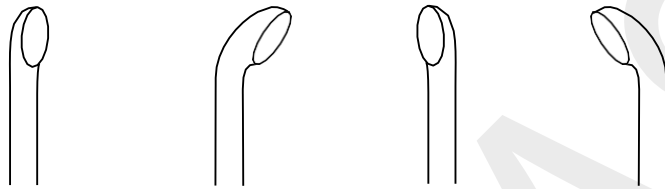

Straight Cup	Forward Angled	Backward Straight	Backward Angled	Cup Size	
MS7418 - 40CL MS7418 -30CL	MS7418 -42CL MS7418 -32CL MS7418 -22CL	MS7418 -44CL MS7418 -34CL MS7418 -24CL	MS7418 -46CL MS7418 -36CL MS7418 -26CL	0.5mm	0000
MS7418 -20CL MS7418 -10CL	MS7418 -12CL MS7418 -82CL	MS7418 -14CL MS7418 -84CL	MS7418 -16CL MS7418 -86CL MS7418 -86CL	1mm	000
				2mm	00
				3mm	0
				4mm	Bone Cutter
					Knife Handl



Container for 12 curettes

MS7418-95

SPINAL

Lempert Curette

- 21cm/8 ¼" overall length

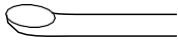

Straight	Cup Size	Angled	Cup Size
MS8010-21	00000	MS8110-21	00000
MS8015-21	0000	MS8115-21	0000
MS8020-21	000	MS8120-21	000
MS8025-21	00	MS8125-21	00
MS8030-21	0	MS8130-21	0
MS8040-21	1	MS8140-21	1

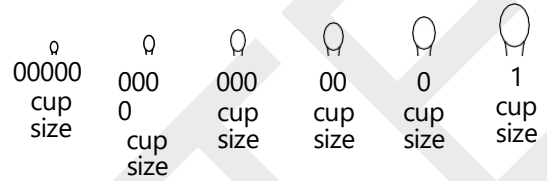

Bruns Curette

- 23cm/9" overall length

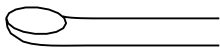

Straight	Cup Size	Angled	Cup Size
MS8220-23	000	MS8320-23	000
MS8225-23	00	MS8325-23	00
MS8230-23	0	MS8330-23	0
MS8240-23	1	MS8340-23	1
MS8250-23	2	MS8350-23	2
MS8260-23	3	MS8360-23	3

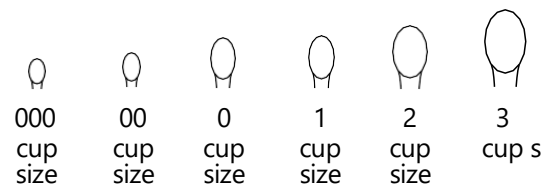

Straight Cup Size Angled Cup Size





SPINAL

Tufnol Handle Micro Curette

- 26cm/10" overall length



MS8010-27	0000	MS8110-27	0000
MS8020-27	000	MS8120-27	000
MS8030-27	00	MS8130-27	00
MS8040-27	0	MS8140-27	0
MS8050-27	1	MS8150-27	1

				
0000 cup size	000 cup size	00 cup size	0 cup size	1 cup size

Cobb Bone Curette

- 28cm/11" length



Straight Cup Size Angled Cup Size

MS7564-20	2.0mm	MS7565-20	2.0mm
MS7564-25	2.5mm	MS7565-25	2.5mm
MS7564-30	3.0mm	MS7565-30	3.0mm
MS7564-35	3.5mm	MS7565-35	3.5mm
MS7564-40	4.0mm	MS7565-40	4.0mm
MS7564-45	4.5mm	MS7565-45	4.5mm
MS7564-50	5.0mm	MS7565-50	5.0mm
MS7564-55	5.5mm	MS7565-55	5.5mm
MS7564-65	6.5mm	MS7565-65	6.5mm
MS7564-80	8.0mm	MS7565-80	8.0mm

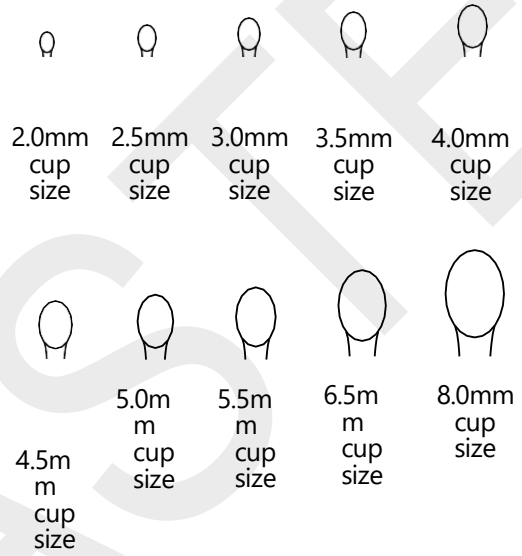

Comfort Handle Curette

- 29cm/11 1/2" overall length
- 20cm/8" handle length



Straight Cup Size Angled Cup Size

MS7561-07	6.5mm	MS7563-07	6.5mm
MS7561-09	8.5mm	MS7563-09	8.5mm
MS7561-11	11mm	MS7563-11	11mm
MS7561-13	13mm	MS7563-13	13mm
MS7561-15	15mm	MS7563-15	15mm

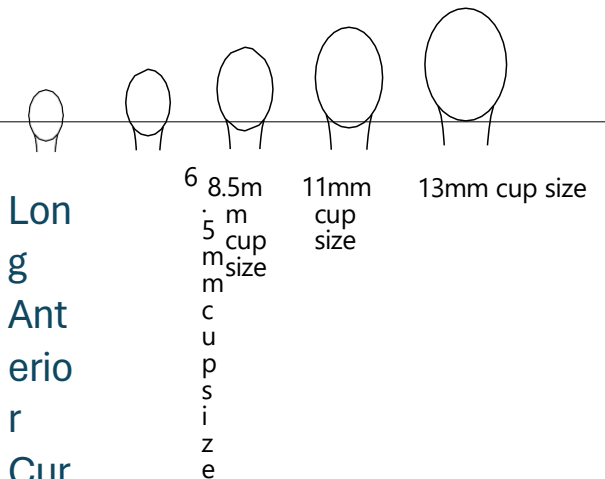

• 38cm/15" overall

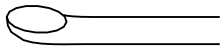

Straight	Cup
MS8043-38	4.3mm
MS8070-38	7mm
MS8080-38	8mm

Angled	Cup
MS8143-38	4.3mm
MS8170-38	7mm
MS8180-38	8mm

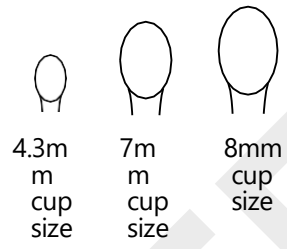

MEDASTEEL

SPINAL

Light-Grip Cervical Curettes

- 26cm/10 1/4" overall length
- 13cm/5 1/4" handle length
- Colour coded handles



Light-Grip Cervical Curette Rack
Holds 12 Cervical Curettes

MS7404 -90

Cup Size	Straight	Forward Angled	Down Angled
6-0	MS7403 -06	MS7405-06	MS7406-06
5-0	MS7403-05	MS7405-05	MS7406-05
4-0	MS7403-04	MS7405-04	MS7406-04
3-0	MS7403-03	MS7405-03	MS7406-03
2-0	MS7403-02	MS7405-02	MS7406-02
0	MS7403-01	MS7405-01	MS7406-01
1	MS7403 -10	MS7405 -10	MS7406 -10
2	MS7403-20	MS7405-20	MS7406-20
3	MS7403-30	MS7405-30	MS7406-30
4	MS7403-40	MS7405-40	MS7406-40
5	MS7403-50	MS7405-50	MS7406-50
6	MS7403-60	MS7405-60	MS7406-60

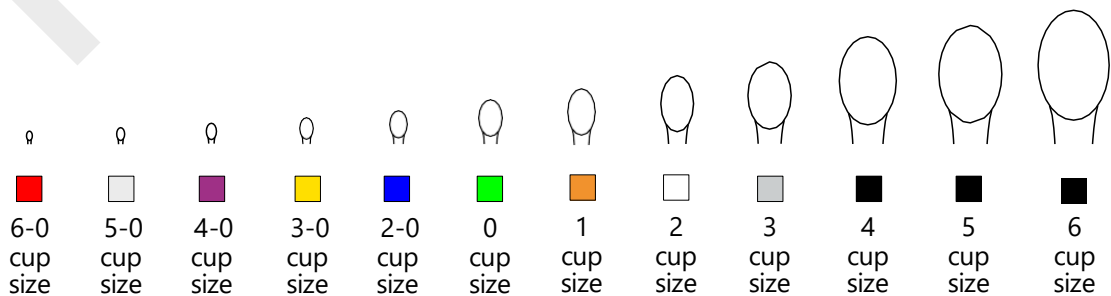

Light-Grip Lumbar Currettes

- 34cm/13 1/2" overall length
- 20cm/8" handle length
- Colour coded handles



Cup Size	Straight	Forward Angled	Down Angled
6-0	MS7407-06	MS7408-06	MS7409-06
5-0	MS7407-05	MS7408-05	MS7409-05
4-0	MS7407-04	MS7408-04	MS7409-04
3-0	MS7407-03	MS7408-03	MS7409-03
2-0	MS7407-02	MS7408-02	MS7409-02
0	MS7407-01	MS7408-01	MS7409-01
1	MS7407-10	MS7408-10	MS7409-10
2	MS7407-20	MS7408-20	MS7409-20
3	MS7407-30	MS7408-30	MS7409-30
4	MS7407-40	MS7408-40	MS7409-40
5	MS7407-50	MS7408-50	MS7409-50
6	MS7407-60	MS7408-60	MS7409-60

Light-Grip Lumbar Curette Rack
Holds 12 Lumbar Currettes

MS7407-90

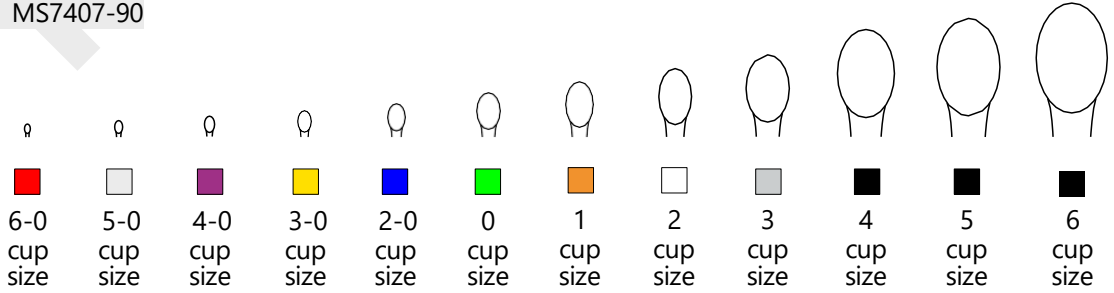

Cones Ring Curette

- 23cm/9" overall length

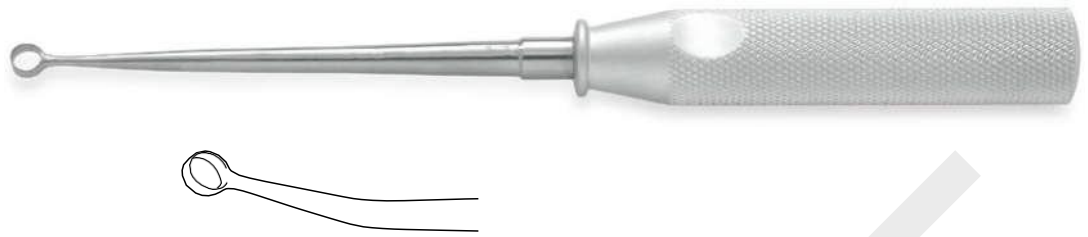

Straight	Ring Size	Angled	Ring Size
MS8803-23	3mm	MS8903-23	3mm
MS8806-23	6mm	MS8906-23	6mm
MS8808-23	8mm	MS8908-23	8mm

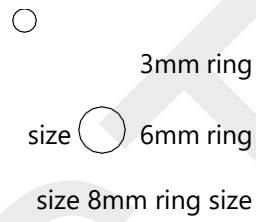

Karl Ring Curette

- 32.5cm/12 3/4" overall length



Straight	Ring	Angled	Ring
MS8886-32	6mm	MS8876-32	6mm
MS8888-32	8mm	MS8878-32	8mm
MS8880-32	10mm	MS8870-32	10mm

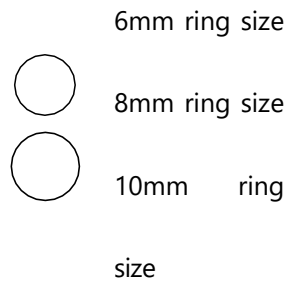

Zielke Curette

- 21cm/8 ¼" overall length



Straight	Size	Angled	Size
MS8608-21	8mm	MS8708-21	8mm
MS8611-21	11mm		11mm

Volkman Double Ended Curette

- 22cm/8 ¾" overall length



	Size
MS8401-22	Small
MS8402-22	Medium
MS8403-22	Large

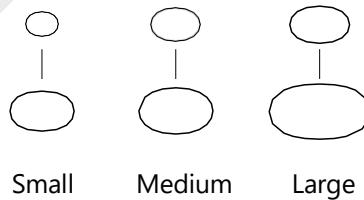

Small

Medium

Large

CASPAR CERVICAL DISTRACTION SET



Caspar Vertebral Body Distraction Set

Complete set consisting of:

MS3001-00

- For retraction of the vertebral body in the cervical spine to allow access to the disc
- Less instrumentation in the disc space
- Distraction screws are secured into the vertebral body either side of the disc, the retractor is then slid over the screws and retracted

Qty	Order Code	Description
1	MS3002-00	Retractor Right
1	MS3003-00	Drill Guide Right
1	MS3004-00	Screw Driver
1	MS3005-00	Distraction Drill
1	MS3006 -14	Sterile Distraction Screws 14mm Boxes of 10

Distraction Retractors

MS3002-00 Right



MS3002-10 Left



CASPAR CERVICAL DISTRACTION SET

Drill Guide

MS3003-00 Right



MS3003-10 Left



Screw Driver

MS3004-00



Distraction Drill

- For pre-drilling pilot holes for distraction screws in combination with the drill guide
- Drill 2mmØ

MS3005-00



Caspar Distraction Screws

- 7cm/2¾ " post length
- Sterile packed

Thread length



Threa
d
lengt
h

MS3006 -12	12mm
MS3006 -14	14mm
MS3006 -16	16mm

Supplied sterile in boxes of 10

LAMINA & VERTEBRAL SPREADERS

Cervical Vertebral Spreader

13cm/5 1/4"
length 3mm tip

	Depth
MS2002-70	70mm
MS2002-95	95mm

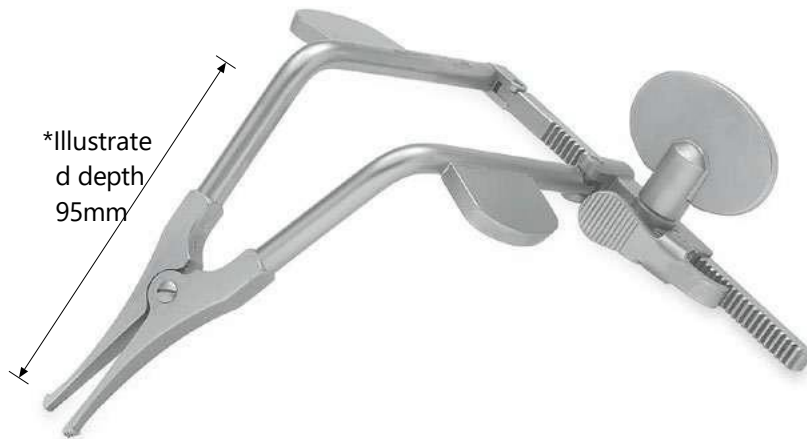

Cloward Cervical Spreader

- 17cm/6 3/4" length
- Max opening 20mm

MS2003 -17



Cloward Lamina Spreader

- 15cm/6" length

MS2004 -70



LAMINA & VERTEBRAL SPREADERS

Baby Inge Lamina Spreader

- 18cm/7" length



7mm
Toothed



MS5134-18

7mm
Smooth



MS5134-18S

7mm
Cross
Serrated



MS5134-18X

Inge Lamina Spreader

- 24cm/9 1/2" length
- Max opening 50mm

MS2006-24



10mm

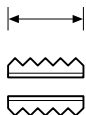

20mm

Scaglietti Lamina

Spreader

- 28cm/11" length
- With speed lock

MS2009-28



Long Anterior Lamina Spreader

- 28cm/11" length
- Max opening 40mm

MS2008-28



MEDAS

HOOKS & PROBES

Pedicle Probe

- 22.5cm/8 ¾" length
- Graduated with ball tip

MS9100 -22



Pedicle Probe

- 27.5cm/11 ½" length
- Graduated with ball tip

MS9132 -27



Adson Dural Hook

- 19cm/7 ½" length
- 3mm tip length

Sharp
MS9103 -19

Blunt
MS9104 -19



Weary Blunt Nerve Hook

- 19.5cm/7 ¾" length
- 6mm iine | tip length

MS9105 -19



Crile Blunt Hook

- 20cm/8" length
- 7mm tip length

MS9111-20



Emmet Sharp Hook

- 22cm/8 ¾" length
- 5mm tip length



MS9106-22

Cushing Blunt Hook

- 28cm/11" length
- 5mm tip length



MS9107 -28

MEDASTE

HOOKS & PROBES

Adson Hook

- 20cm/8" length
- 5mm tip length



Ball Tipped Probe

- 23cm/9" length
- 2mm Ø ball

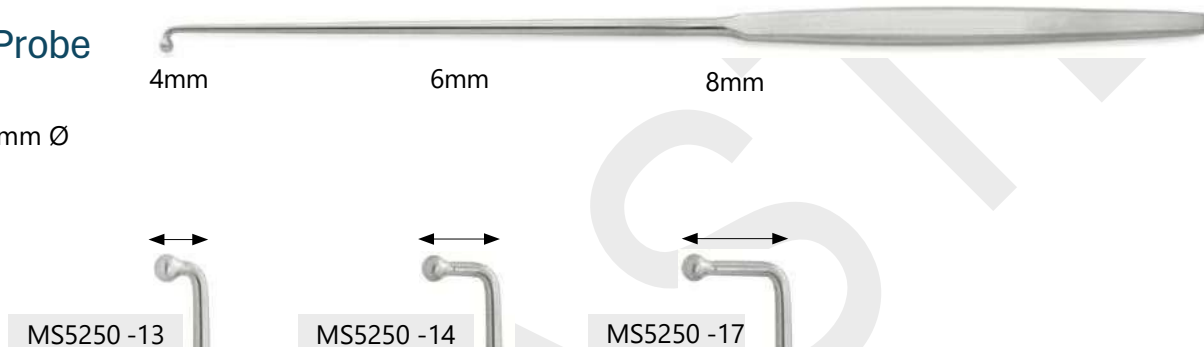

Ball Tipped Probe - Fine Pattern

- 23cm/9" length
- 1mm Ø ball

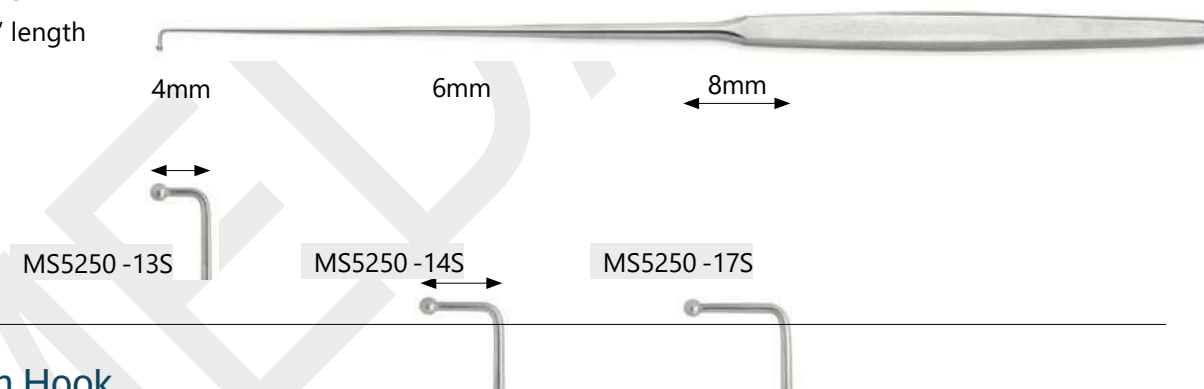

Manipulation Hook

- 23.5cm/9 1/4" length
- 4mm tip length



Blalock Blunt Hook

- 24cm/9 1/2" length
- 5mm tip length



Caspar Exploration Hook Insulated

- 24.5cm/9 ¾" length
- Insulated shaft



MS9151-24

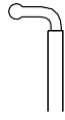

MS9152-24

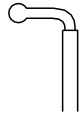

MS9153-24

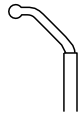

MS9154-24

MEDDASTEEL

RHOTON MICRO DISSECTORS

Titanium Micro Round Dissectors

- 19cm/7 1/2" length

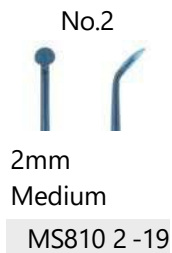

Titanium Micro Elevators

- 19cm/7 1/2" length

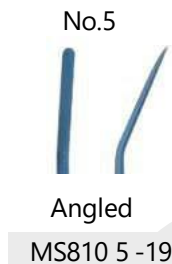

Titanium Micro Spatula Dissectors

- 19cm/7 1/2" length



Titanium Micro Hooks

- 19cm/7 1/2" length



No.9



90° Semi-
sharp

MS810 9 -19

No.10



90° Blunt

MS811 0 -19

No.11



45° Semi-
sharp

MS8111-19

No.12



Straight point Needle

MS811 2 -19

MEDDASTEEL

RHOTON MICRO DISSECTORS

Titanium Micro Curettes

- 19cm/7 1/2" length

No.13



Small Cup

MS811 3 -19

No.14



Large Cup

MS811 4 -19



Titanium Micro Ball Dissectors

- 19cm/7 1/2" length

No.15



Straight

MS811 5 -19

No.16



90°3mm Tip

MS811 6 -19

No.17



90°5mm Tip

MS811 7 -19

No.18



40°4mm Tip

MS811 8 -19

No.19



40°8mm Tip

MS811 9 -19



Complete Set

- Including Rack and 19 Micro Dissectors

MS810 0 -19



Dissector Sterilising Rack

- To hold 19 Micro Dissectors

MS810 0-00



NERVE ROOT RETRACTORS

Love Bayonet Nerve Root Retractor

- 21cm/8 ¼" length

	Width
MS5000-21	4mm



Krayenbuhl Nerve Root Retractor

- Double bayonet

		Width
21cm/8 ¼"	MS5041-	3mm
24cm/9 ½"	21	4mm



Caspar Bayonet Nerve Root Retractor

- 24cm/9 ½" length

	Width
MS5054-24	4mm
MS5056-24	6mm

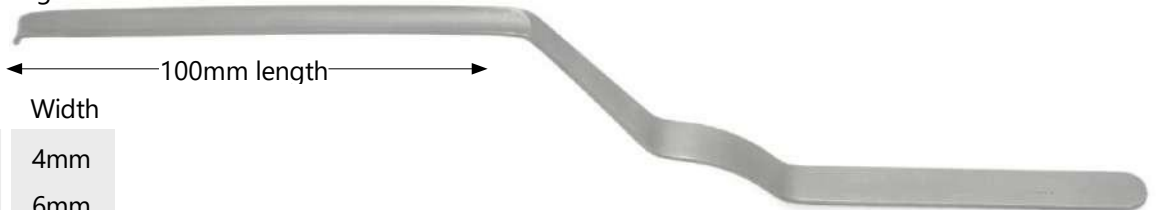

O'Connell Nerve Root Retractor

- 21.5cm/8 ½" length

MS5002-21



Love Nerve Root Retractor

- 22cm/8 ¾" length

MS5010-	Straight
22	25° Angled*
MS5011-	90° Angled



McCulloch Net

- 12.5cm/5" working length
- 90° angled
- 6mm tip

MS5250-02



MEDAS

NERVE ROOT RETRACTORS

Shepherd Suction Nerve Root Retractor

- With suction aspiration
- Fibre optic illumination
- 4mm tip width

26cm/10 1/2" length

MS5015 -26

31cm/12 1/4" length

MS5015 -31



Nerve Root Retractor

- 31cm/12" length
- With suction
- 7mm tip width

MS5013-31



Hess Nerve Root Retractor

- 19cm/7 1/2" length

	Width
MS5003 -19	3mm
MS5004 -19	4mm
MS5005 -19	5mm
MS5007-19	7mm

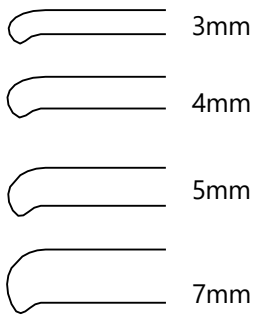

Nerve Root Retractor

- 19cm/7 1/2" length
- With fibre optic illumination



	Width
MS5033 - 19	3mm
	5mm

HAND HELD RETRACTORS

Meyerding Retractor

• 22.5cm/9"

	Blade	
MS5050-22	50mm	x
MS5075-22	16mm	75mm
MS5090-22	x	25mm

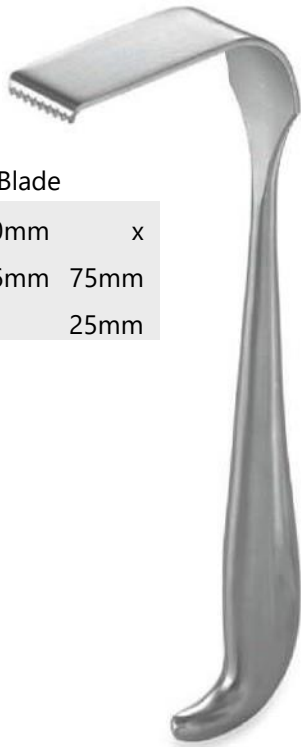

Langenbeck Retractor

• 21.5cm/8 1/2" length

	Blade size		
MS5122-21	22mm x 6mm		Small
MS5145-21	45mm x 13mm		Mediu
MS5165-21	65mm x 25mm		m Large
MS5190-21	90mm x 20mm		X-Large



Volkman Catspaw Retractor

• 21.5cm/8 1/2" length
• Semi sharp teeth



15 x 15mm
3 Prong
MS5015 -21



15 x 20mm
4 Prong
MS5020 -21

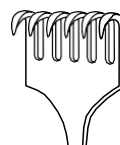

15 x 30mm
6 Prong
MS5030 -21



Taylor Hip Retractor

19cm/7 1/2" length

MS5006 -19	70mm
MS5008 -19	85mm
MS5010 -19	100m



Cloward Style Blade Retractor

11cm/4 1/4" length

MS5013 -11	13m
MS5018 -11	m
MS5020 -11	18m

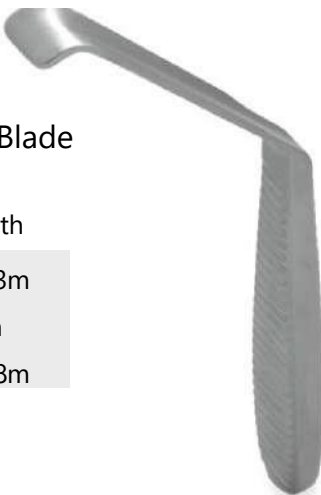

SELF RETAINING

West's S/R Retractor

- 14cm/5 1/2" length
- 3 x 4 Sharp prongs
- Prong depth 18mm

MS4003 -14



Weitlaner S/R Retractor

- 14cm/5 1/2" length
- 3 x 4 Blunt prongs
- Prong depth 18mm

MS4002 -14

Mollison S/R Retractor - Child

- 13cm/5 1/4" length
- 2 x 2 Sharp prongs 12mm depth

MS4005 -13



Mollison S/R Retractor - Adult

- 17cm/6 3/4" length
- 4 x 4 Sharp prongs 15mm dept

MS4005 -17



Jefferson S/R Retractor

- 13cm/5 1/4" length
- 3 x 4 Blunt prongs 16mm depth

MS4008 -13



SELF RETAINING

Irwin S/R Retractor

- 17.5cm/6 ³/₄" length
- 4 x 4 Sharp prongs
- Prong depth 20mm

MS4018 -17



Travers S/R Retractor

- 20cm/8" length
- 4 x 5 Blunt prongs
- Prong depth 26mm

MS4004-20



Norfolk and Norwich S/R Retractor

- 20cm/8" length
- 4 x 5 Blunt prongs
- Prong depth 50mm x 23mm width

MS4000-20



Norfolk and Norwich Deeper Prongs S/R Retractor

- 20cm/8" length
- 4 x 5 Blunt prongs
- Prong depth 70mm x 23mm width

MS4000-22



SELF RETAINING

Cones Self Retaining Retractor

- 3x 4 Prongs
- Jointed arms

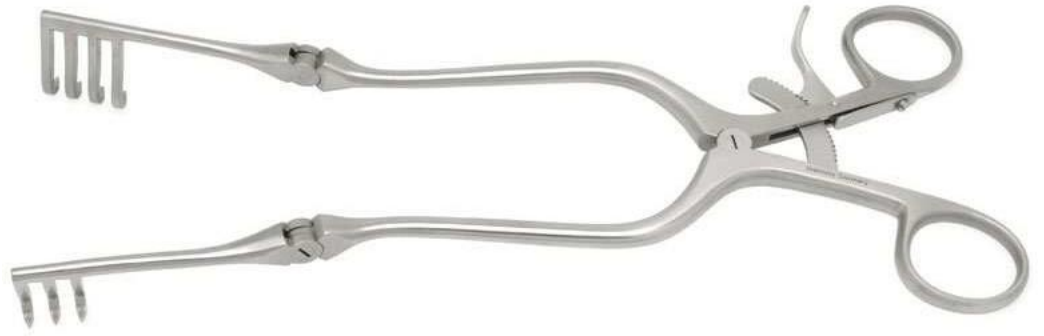

Blunt Prongs	Length	Depth	Sharp Prongs	Length	Depth
MS4064 -13	13cm/5"	15mm	MS4063 -13	13cm/5"	15mm
MS4066 -16	16cm/6 1/2"	15mm	MS4065 -16	16cm/6 1/2"	15mm
MS4068-20	20cm/8"	20mm	MS4067-20	20cm/8"	20mm
MS4070-24	24cm/9 1/2"	25mm	MS4069-24	24cm/9 1/2"	25mm

Harvey Jackson Self Retaining Retractor

- 30.5cm/12" length
- Prong depth 45mm
- 3x 3 Sharp prongs

MS4010-30



Beckman - Adson Retractor

- 33cm/13" length
- 4 x 5 Blunt prongs
- Prong depth 32mm
- Jointed arms

MS4001-32



SELF RETAINING

Gelpi Laminectomy Retractor

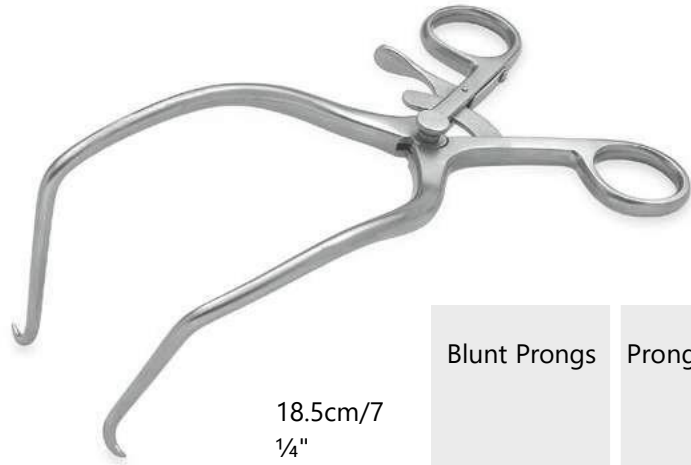

	Sharp Prongs	Prong depth
18.5cm/7 1/4"	MS4030 -16	30mm
	MS4050 -16	50mm
19.5cm/7 3/4"	MS4070 -16	70mm
	MS4090 -16	90mm
20cm/8"		
20cm/8"		

	Blunt Prongs	Prong depth
18.5cm/7 1/4"		
19.5cm/7 3/4"		
20cm/8"	MS4030 -	30m
20cm/8"	16B MS4050	m
	-16B	50m
20cm/8"	MS4070 -	m

Hardman Retractor

- 20cm/8" length

	Prong depth
MS4550-20	50mm equal prongs
MS4500-20	long prong - Left*
MS4300-20	long prong - Right

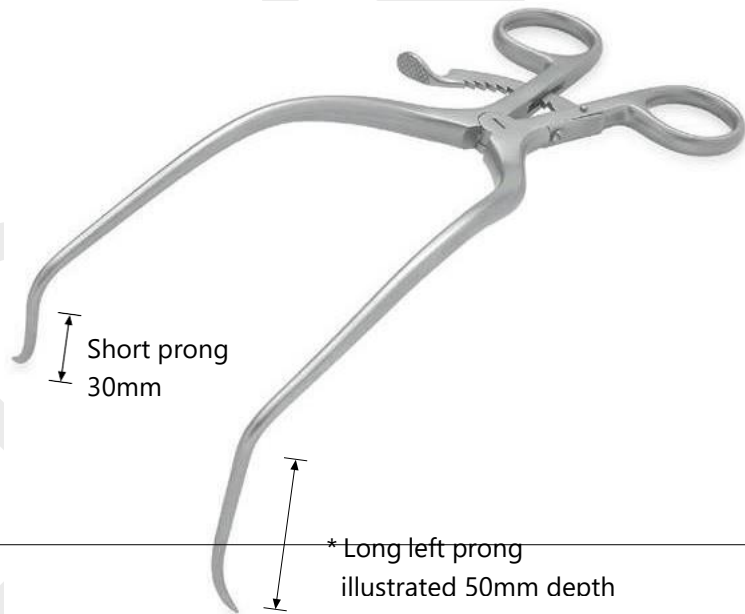

Meyerding Hemi Laminectomy Retractor

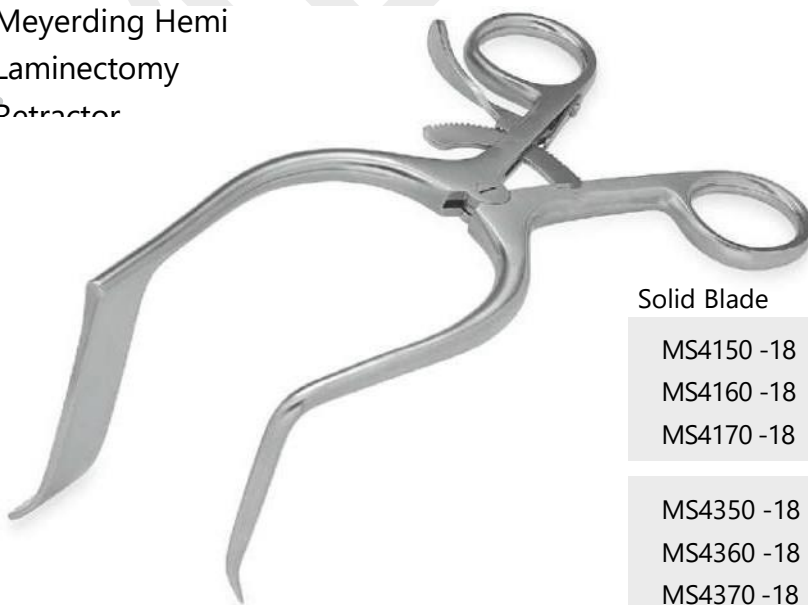

Solid Blade	Blade Size	Solid Blade Right	
MS4150 -18	50 x 10mm	MS4250 -18	Narrow Blade
MS4160 -18	60 x 10mm	MS4260 -18	
MS4170 -18	70 x 10mm	MS4270 -18	
MS4350 -18	50 x 20mm	MS4450 -18	Wide Blade
MS4360 -18	60 x 20mm	MS4460 -18	
MS4370 -18	70 x 20mm	MS4470 -18	

SELF RETAINING

Viper Hinged Scoliosis Retractor

30cm/11 ¾"
length Sharp

Viper Hinged Scoliosis Retractor

- 30cm/11 ¾"
length Sharp

Depth Prongs

MS7248- 40mm

38H 70mm

MS7248- 100m

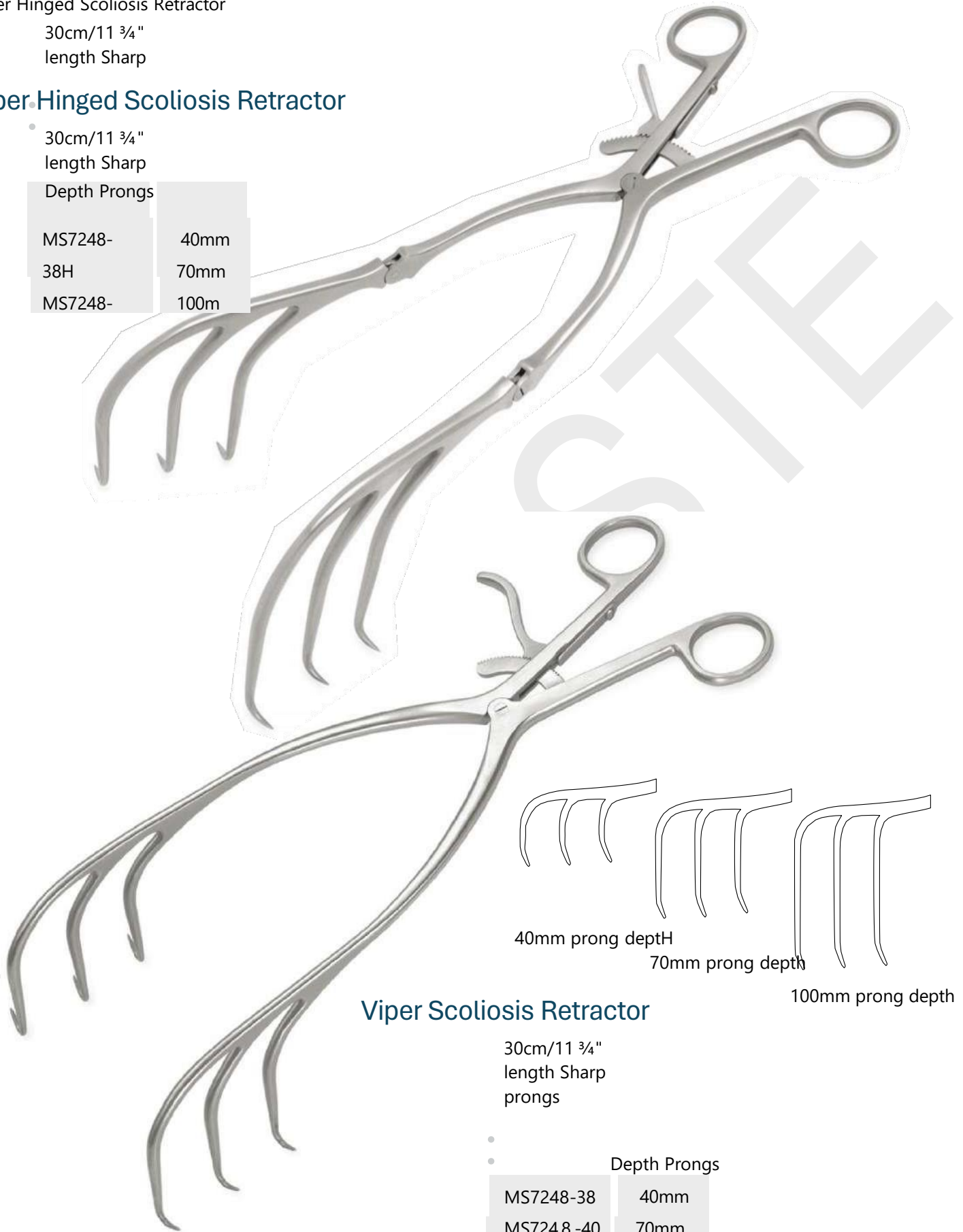

Viper Scoliosis Retractor

30cm/11 ¾"
length Sharp
prongs

	Depth Prongs
MS7248-38	40mm
MS7248 -40	70mm
MS7248 -50	100m

McCULLOCH RETRACTOR SET



- This Specialist Retractor allows the consultant the optimal exposure to the disc with the minimum incision.
- The design of the retractor allows unhindered access around the wound with the jointed arms folding along the patients back.
- The black finish eliminates distracting reflections under the microscope during surgery.
- The wide selection of blades available allows the surgeon full flexibility in approaches to the disc.

Basic McCulloch Retractor Set

MS5200-00

Complete set consisting of:

Qty	Order Code	Description
1 each	MS5202-00	Retractor Frame
4 pairs	MS5204-40	Wide Muscle Blades Sizes 4cm to 7cm depth
4 pairs	MS5206-40	Narrow Muscle Blades Sizes 4cm to 7cm depth
4 each	MS5208-40	Hook Blades Sizes 3cm to 6cm depth
4 each	MS5210-40	Toothed Blades Sizes 3cm to 6cm depth
1 each	MS5200 -10	Instrument Container

Extended McCulloch Retractor Set

MS5200-01

Complete set consisting of:

Qty	Order Code	Description
2 each	MS5202-00	Retractor Frames
6 pairs	MS5204-60	Wide Muscle Blades Sizes 3cm to 8cm depth
6 pairs	MS5206-60	Narrow Muscle Blades Sizes 3cm to 8cm depth
6 each	MS5208-60	Hook Blades Sizes 2cm to 7cm depth
6 each	MS5210-60	Toothed Blades Sizes 2cm to 7cm depth
1 each	MS5200 -10	Instrument Container

McCULLOCH RETRACTOR SET

Jointed Arms





Retractor

- Frame Jointed arms Maximum spread 70mm

MS5202-00

Retractor Frame
Rigid arms

MS5203-00

Retractor Frame
Extra long rack 140mm spread

MS5202-00S



Wide Muscle Blades - 6 Teeth

Extra deep

27mm width

MS5204 -03	3cm
MS5204 -04	depth
MS5204 -05	4cm
MS5204 -06	depth
MS5204 -07	5cm
MS5204 -08	depth
	6cm
	depth
	7cm



Hook Blades

Extra deep

MS5208 -02	2cm
MS5208 -03	depth
MS5208 -04	3cm
MS5208 -05	depth
MS5208 -06	4cm
MS5208 -07	depth
	5cm
	depth
	6cm



Extra deep

20mm width

MS5206 -03	3cm
MS5206 -04	depth
MS5206 -05	4cm
MS5206 -06	depth
MS5206 -07	5cm
MS5206 -08	depth
	6cm
	depth
	7cm

des - 4



MS5210 -02	2cm
MS5210 -03	depth
MS5210 -04	3cm
MS5210 -05	depth
MS5210 -06	4cm
MS5210 -07	depth
	5cm
	depth
	6cm



Thin Muscle Blades - 2 Teeth
17mm width

MS5207-03	3cm depth
MS5207-04	4cm depth
MS5207-05	5cm depth
MS5207-06	6cm depth
MS5207-07	7cm depth
MS5207-08	8cm depth

MICRO DISCECTOMY SET

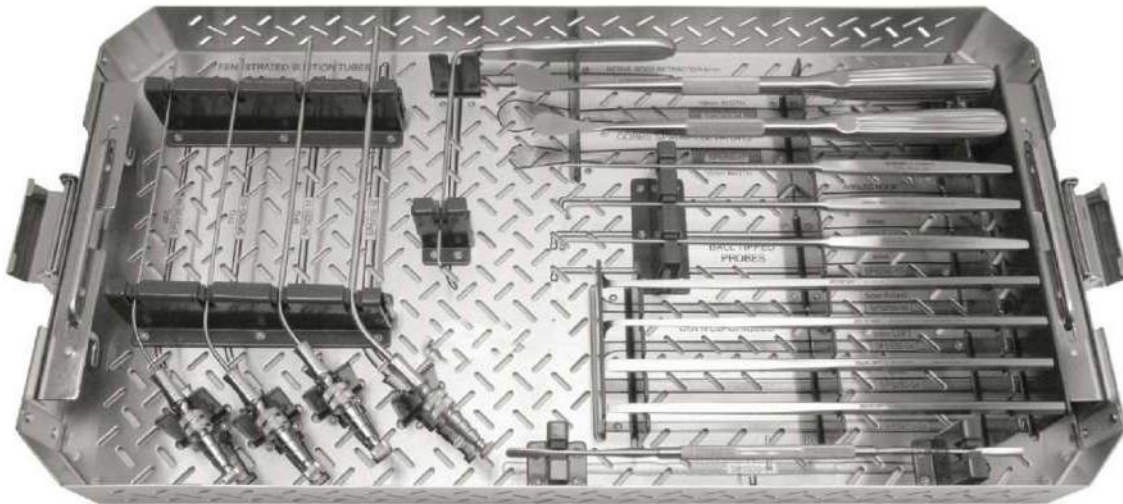

McCulloch Style Instrument Set with Container

MS5200-05

Complete set consisting of:

Qty Order Code Description

1	MS5250 -15	McCulloch Spinal Hook, 4mm tip - 23cm/9" length
1	MS5250 -13	McCulloch Spinal Probe, 4mm tip - 23cm/9" length
1	MS5250 -14	McCulloch Spinal Probe, 6mm tip - 23cm/9" length
1	MS5250-07	Cobb Spinal Elevator, 12mm width - 26cm/10 ¼" length
1	MS5250-08	Cobb Spinal Elevator, 19mm width - 26cm/10 ¼" length
1	MS5250-03	Spinal Osteotome, 4mm width - 22cm/8½" length
1	MS5250-04	Spinal Osteotome, 6mm width - 22cm/8½" length
1	MS5250-05	'Hockey Stick' Chisel, 5mm width - 22cm/8 ½" length, curved right
1	MS5250-06	'Hockey Stick' Chisel, 5mm width - 22cm/8 ½" length, curved left
1	MS5250-01	Elevator Double Ended, 24cm/9 ¾" length
1	MS5250-09	McCulloch Suction Tube, Fenestrated tip, 23cm/9" length, 6FG, 2.0mm Ø
1	MS5250 -10	McCulloch Suction Tube, Fenestrated tip, 23cm/9" length, 7FG, 2.3mm Ø
1	MS5250 -11	McCulloch Suction Tube, Fenestrated tip, 23cm/9" length, 9FG, 3.0mm Ø
1	MS5250 -12	McCulloch Suction Tube, Fenestrated tip, 23cm/9" length, 12FG, 4.0mm Ø
1	MS5250 -02	McCulloch Nerve Root Retractor, 9 0° angled, 6mm tip, 12.5cm/5" working length

McCulloch Style Spinal Hook/Probe

- 23cm/9" length



Hook
Tip
4mm



MS5250-15

Probe Ball
Tip 4mm



MS5250-13

Probe Ball
Tip 6mm



MS5250-14

Probe Ball
Tip 8mm



MS5250-17

MEDASTEEL

MICRO DISCECTOMY SET

Cobb Spinal Elevator

- 26cm/10 1/4" length



Width

MS5250-07	12mm
MS5250-08	19mm

Spinal Osteotome

- 22cm/8 1/2" length



Width

MS5250-03	4mm
MS5250-04	6mm

'Hockey Stick' Chisel

- 22cm/8 3/4" length
- 5mm width



MS5250-05 Curved

MS5250-06 right

Curved left

Elevator Double Ended

- 24cm/9 3/4" length



MS5250-01

McCulloch Suction Tube

- 23cm/9" length
- Fenestrated tip



FG Diameter

MS5250-09	6FG	2.0mm Ø
MS5250-10	7FG	2.3mm Ø
MS5250-11	9FG	3.0mm Ø
MS5250-12	12FG	4.0mm Ø

McCulloch Nerve Root Retractor

- 12.5cm/5" working length
- 90° angled
- 6mm tip

MS5250-02



MEDAS

'BLACK BELT' CERVICAL



RETRACTOR SET

Standard 'Black Belt' Retractor with the addition of Micro Discectomy Attachments as detailed on page 56.

* Titanium Blade Set illustration

An advanced cervical retractor system suitable for both anterior and posterior cervical surgery but with attachments for micro discectomy surgery.

Basic 'Black Belt' Cervical Retractor System

7320-00

Complete set consisting of:

Qty	Order Code	Description
1	7320 -10	Retractor Frame RIGHT
1	7320 -20	Retractor Frame LEFT
1	7320 -30	Retractor Frame OFFSET
2	7320 -40	Blade Insertion Clamps
14	7322-34/70	Pronged Blades 34mm-70mm
14	7324-34/70	Blunt Blades 34mm-70mm
12	7326-40/55	Two Level Pronged Blades 40mm-55mm
6	7328 -40/55	Two Level Blunt Blades 40mm-55mm
1	7320-50	Container

Coloured Titanium

7320-05M

Extended 'Black Belt' Cervical Retractor System

Complete set consisting of:

Qty	Order Code	Description
1	7320 -10M	Retractor Frame RIGHT
1	7320 -20M	Retractor Frame LEFT
1	7320 -30M	Retractor Frame OFFSET
2	7320 -40M	Blade Insertion Clamps
14	7322-34/70M	Pronged Blades 34mm-70mm
14	7324-34/70M	Blunt Blades 34mm-70mm
12	7326-40/55M	Two Level Pronged Blades 40mm-55mm
6	7328 -40/55M	Two Level Blunt Blades 40mm-55mm
1	7320 -50M	Container
1	7321 -10	Micro Disc attachment
1	7321-20	Spike Blade
1	7321-30	T-Shape Blade
1	7321-40	Inner Spine Ligament Blade
1	7321-85	Pronged Blade 85mm depth

Extended 'Black Belt' Cervical Retractor System

Consisting of:

'BLACK BELT' CERVICAL RETRACTOR SET

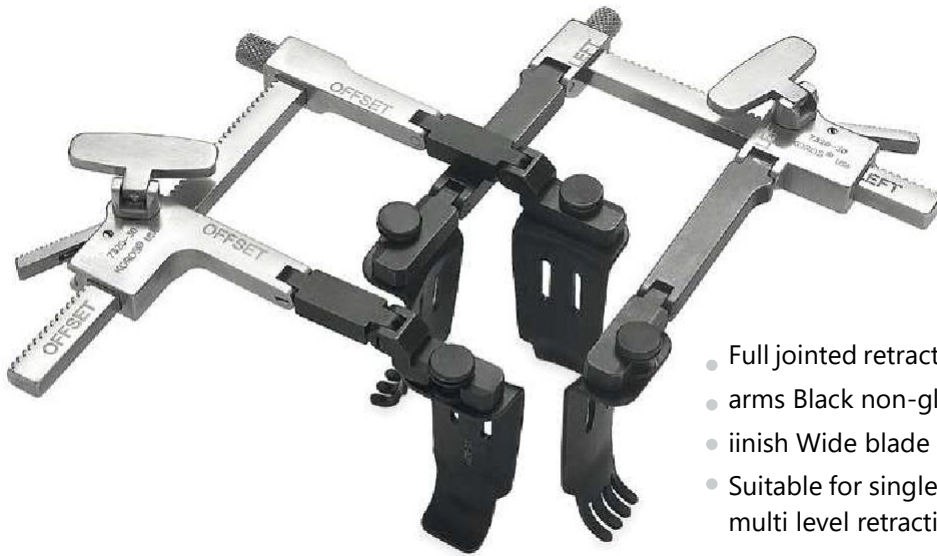

- Full jointed retractor
- arms Black non-glare
- Finish Wide blade range
- Suitable for single or multi level retraction

Blades

- The blade shape is designed to resist climbing out of the surgical site
- The wider two level blades have an extra bend near the tip, which follows the contour of the vertebrae for visualising

tip, which follows the contour of the vertebrae for visualising



22mm wide blunt blade

22mm wide pronged blade

27mm wide two level blunt blade

27mm wide two level pronged blade

17mm wide optional narrow Cervical blades 40mm to 60mm depth

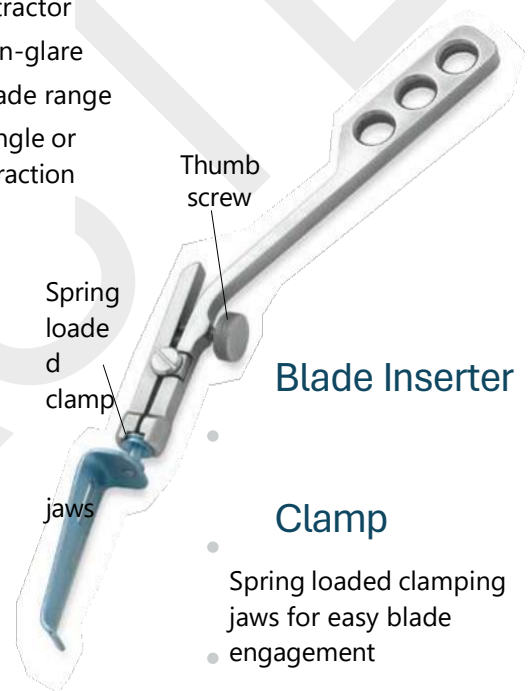

Blade Inserter

Clamp

- Spring loaded clamping jaws for easy blade engagement
- Clamp handles create minimal visual obstruction
- Blade/clamp assembly may be used for hand retraction
- Clamps are quickly/easily removed after retractor arms have securely engaged the blades

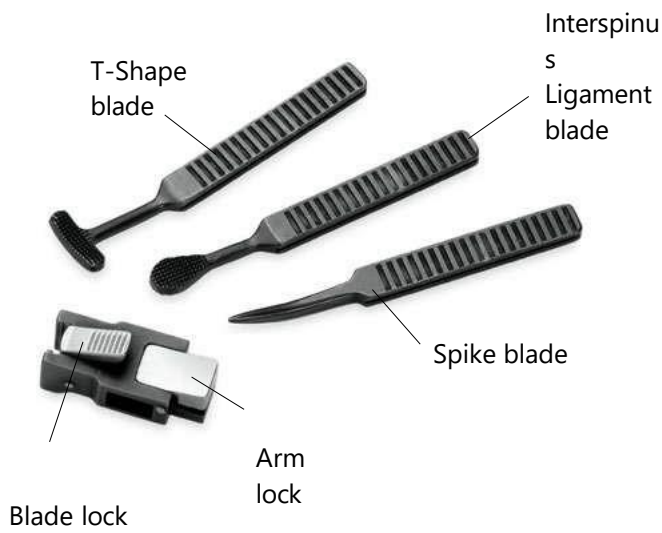

Lumbar Micro Discectomy Attachments

With this set the standard Cervical Retractor becomes a Lumbar Microdiscectomy Retractor unit.

7321-00

Complete set consisting of:

Qty	Order Code	Description
1	7321 -10	Micro Disc attachment
1	7321-20	Spike Blade
1	7321 -30	T-Shape Blade
1	7321-40	Inner Spine Ligament Blade
1	7322 -85	Pronged Blade 85mm

MEDAS

SUPER -SLIDE II LAMINECTOMY RETRACTOR SET

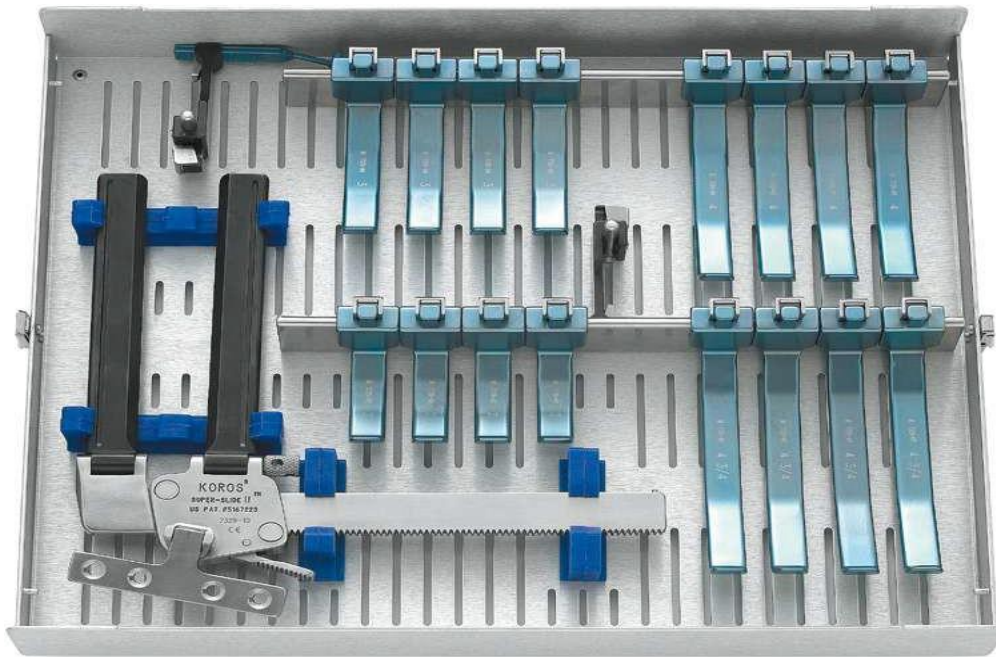

* Titanium Blade Set illustrated

A powerful retractor with a selection of blade depths which can be positioned anywhere along the retractor arms. Allows excellent exposure of the spine in Pedicle Screw and Laminectomy procedures.

Super-Slide Retractor Basic Set

7329-00

Complete set consisting of:

Qty	Order Code	Description
1	7329 -10	Retractor Frame
4	7329-20	Small Blades 2" depth
4	7329-30	Medium Blades 3" depth
4	7329-40	Large Blades 4" depth
1	7329-50	Instrument Container

Super-Slide Retractor Extended Set

7329-05 Includes components of basic set plus:

4	7329-47	Supplementary Blades 4¾" depth
2	7329-60	Unilateral Blade heads
2	7329-62	Unilateral T-Blades
Qty	Order Code	Description

Titanium Super-Slide Retractor Basic Set

7329-06

Complete set consisting of:

Qty	Order Code	Description
1	7329 -10	Retractor Frame
4	7329-82	Small Titanium Blades 2" depth
4	7329-84	Medium Titanium Blades 3" depth
4	7329-86	Large Titanium Blades 4" depth
1	7329-90	Instrument Container

Titanium Super-Slide Retractor Extended Set

7329-09 Includes components of titanium basic set plus:

4	7329-87	Supplementary Titanium Blades 4¾" depth
2	7329-60	Unilateral Blade Heads
2	7329-62M	Unilateral Titanium T-Blades
Qty	Order Code	Description

SUPER -SLIDE II LAMINECTOMY RETRACTOR SET

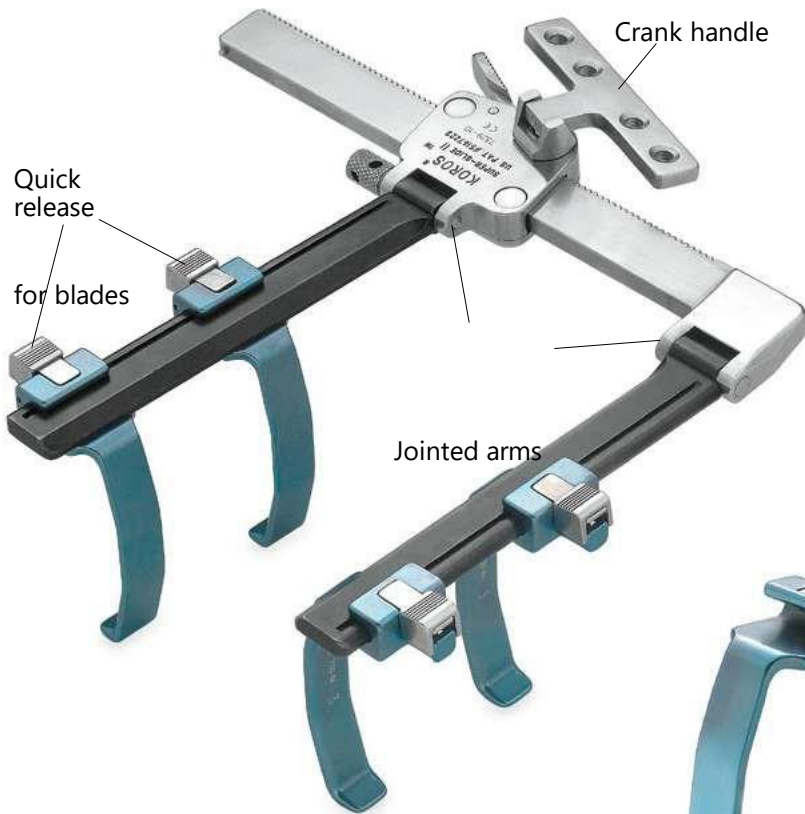

Super-Slide Retractor Blades

- Will not slip out of wound during surgery
- Narrow blade design minimises potential of tissue necrosis at blade and tissue contact point
- Blades feature quick release locking system

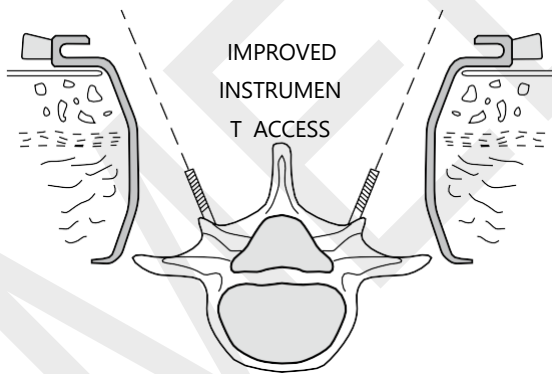

Supplementary 7329-87 4 ³ / ₄ " depth	Large 7329-86 4" depth	Medium 7329-84 3" depth	Small 7329-82 2" depth
---	------------------------------	-------------------------------	------------------------------

Unilateral Blade Attachment

- Blades lock into any chosen position along the retractor arms and may be changed at any time during surgery
- Arm locks allow the surgeon the choice of either attaching to the retractor arms then placing the unit into the wound or placing the blades into the wound then engaging the frame arms
- To obtain a unilateral exposure, use the unilateral blade attachments contained in the extended set. The T-Blade is designed to attain a firm purchase on the Spinous process
- The T-Blade can be adjusted to the correct depth with the blade lock

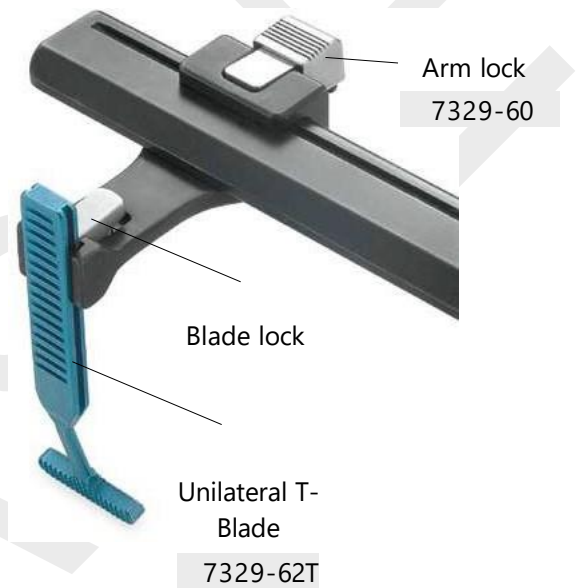

CASPAR MICRO LUMBAR DISCECTOMY RETRACTOR SET

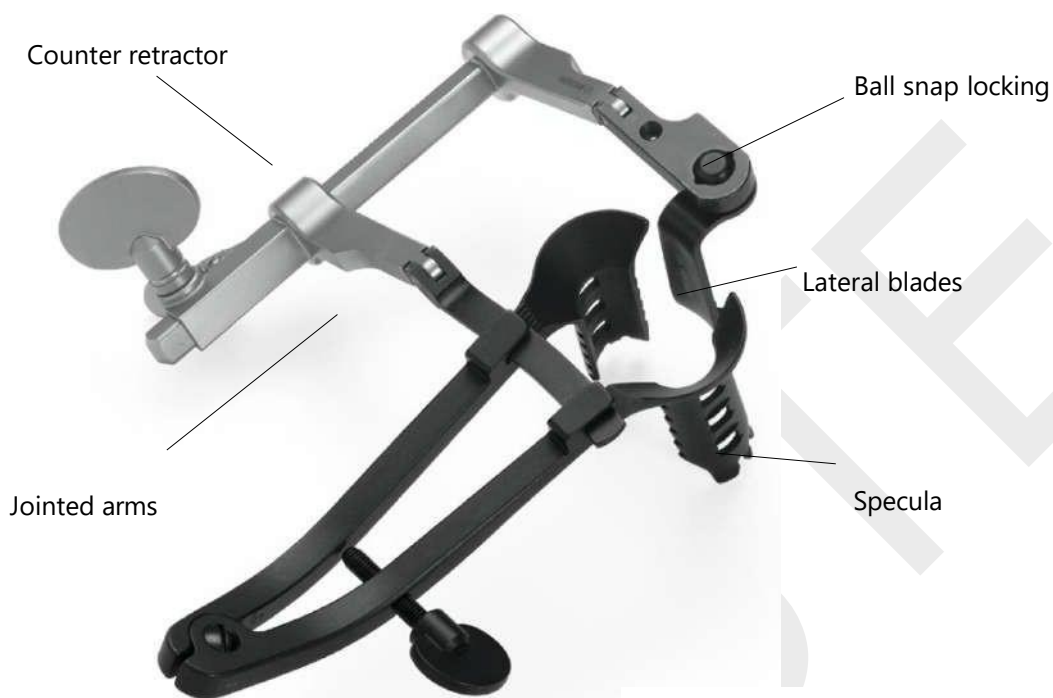

Caspar Micro Discectomy Retractor

- This Retractor Set allows a micro surgery approach to Lumbar Disc
- Specula have a black surface finish to prevent glare
- Fenestrated blades on the specula reduce the risk of movement during surgery

Complete Set

SP510 0-00

Consisting of:

Lateral Blades	Depth	Specula	Depth
MS5101-40	40mm	MS5100-40	40mm
MS5101-45	45mm	MS5100-45	45mm
MS5101-50	50mm	MS5100-50	50mm
MS5101-55	55mm	MS5100-55	55mm
MS5101-60	60mm	MS5100-60	60mm
MS5101-65	65mm	MS5100-65	65mm
MS5101-75	75mm	MS5100-75	75mm
MS5101-80	80mm	MS5100-80	80mm
MS5101-85	85mm	MS5100-85	85mm
MS5101-10	100mm	MS5100-10	100mm

MS5102-00	Counter Retractor Frame
MS5103-00	Blade Ejector Forceps
MS5104-00	Sterilising Container
MS5105-00	Tray Insert for Specula
MS5106-00	Tray Insert for Lateral Blades

Optional extra depth

CASPAR MICRO LUMBAR DISCECTOMY RETRACTOR SET

Lateral Blades



Blade Ejector Forceps

MS5103-00



Specula Range



Caspar Micro Discectomy Retractor Frame

MS5102-00



PICCOLINO MINI LUMBAR RETRACTOR SET

Counter retractor arm

Counter Retractor Frame

Specula

Lateral blades

Lateral Blades Radiolucent

depth

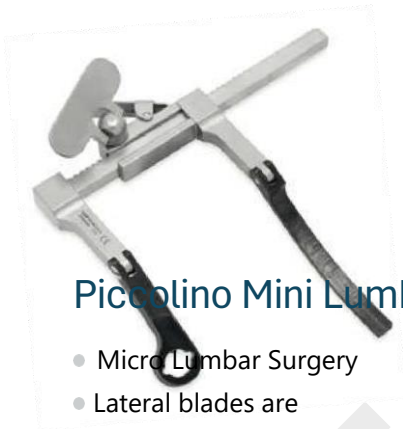

Piccolino Mini Lumbar Retractor Set

- Micro Lumbar Surgery
- Lateral blades are radiolucent
- Reduced 20mm incision

Complete Set

SP570 0-00

Consisting of:

Lateral Blades

Depth

Specula

Depth

Specula

MS5760-83	40mm
MS576 0-84	45mm
MS576 0-85	50mm
MS576 0-86	55mm
MS576 0-87	60mm
MS576 0-88	65mm
MS576 0-89	75mm

SP575 8-35	40mm
SP 575 8-36	45mm
SP 575 8-37	50mm
SP 575 8-38	55mm
SP 575 8-39	60mm
SP 575 8-40	65mm
SP 575 8-42	75mm
SP 575 8-44	85mm

MS5757 -52 Counter Retractor Frame

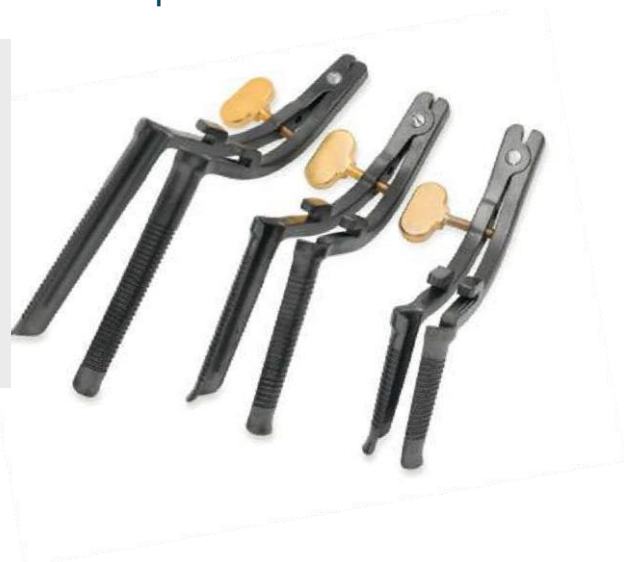



BLACK BELT MICRO DISCECTOMY RETRACTOR SET

Black Belt Micro Discectomy Retractor Set

A specialist retractor for Lumbar Micro Discectomy Surgery featuring:

- Jointed retractor arms
- Adjustable blade depth
- Range of pronged blades
- Powerful ratchet action with quick release mechanism

7276-00 **Complete Set**

Complete set consisting of:

Qty	Order Code	Description
1	7276 -10	Retractor Frame
1	7276 -15	Blade Inserting Clamp
1	7276-20	Spike Blade
1	7276-30	T-Shape Blade
1	7276-35	Inner Spine - Ligament Blade
1	7276-40	Pronged Blade 40mm
1	7276-45	Pronged Blade 45mm
1	7276-50	Pronged Blade 50mm
1	7276-60	Pronged Blade 60mm
1	7276-70	Pronged Blade 70mm
1	7276-85	Pronged Blade 85mm
1	7276-90	Sterilising Container

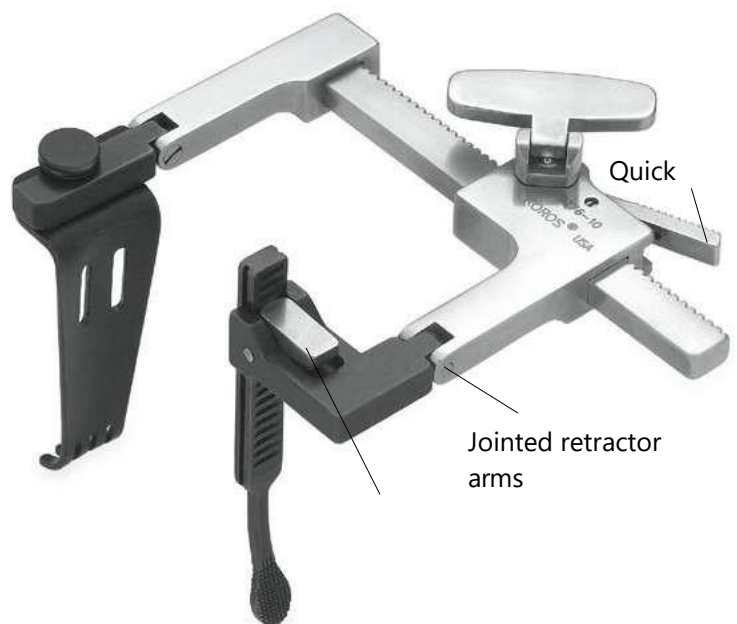
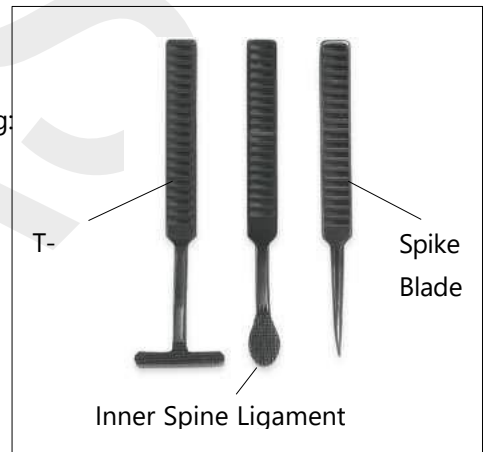

LUMBAR SPINAL SET

LEVEL 3



LEVEL 2

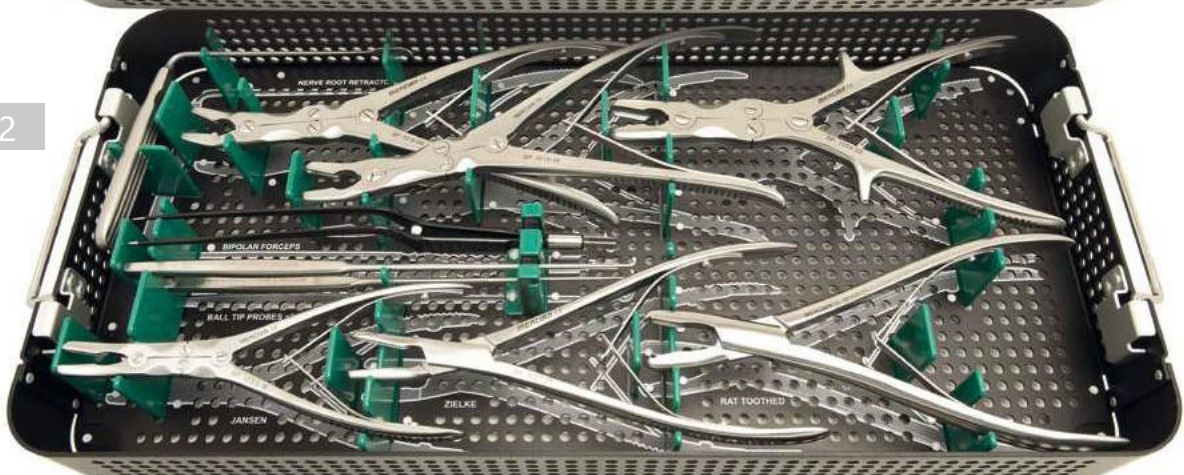

LEVEL 1



Mercian introduce a new set of spinal instruments for lumbar spine surgery.

The Mercian Lumbar Spine Set has three levels of instruments consisting of Bone Currettes and Nerve Root Retractors on the first level, Bone Nibblers and Hooks on the second level with the lower level consisting of Kerrison Punches 2mm to 5mm and Disc Ronguers.



LUMBAR SPINAL SET

SP100 0-00 Complete Set

Complete set consisting of:

Qty	Order Code	Description	LEVEL
Titanium Kerrison Punches - x 4			
1	MS 4082 ETi	Kerrison Titanium Punch, 2mm - 20cm/8"	LEVEL
1	MS 4083 ETi	length Kerrison Titanium Punch, 3mm -	
1	MS 4084 ETi	20cm/8" length Kerrison Titanium Punch,	
1	MS 4085 ETi	4mm - 20cm/8" length Kerrison Titanium	
Punch, 5mm - 20cm/8" length			
Disc Ronguers x 6			
1	C7-S	Disc Ronguer, 2mm - 18cm/7" straight	LEVEL
1	LG7-	Cushing Disc Ronguer, 2mm - 18cm/7" straight	
1	S S7-	Love-Gruenwald Disc Ronguer, 3mm - 18cm/7"	
1	S LG7	Love-Gruenwald Disc Ronguer, 3mm - 18cm/7"	
1	-U S7	straight Spurling Disc Ronguer, 4mm - 18cm/7"	
1	..	straight Spurling Disc Ronguer, 4mm - 18cm/7"	
Bone Nibblers x 4			
1	MS1018-24	Leksell Bone Nibbler, 3mm bite size - 24cm/9 1/2"	LEVEL
1	length MS1019-24	Leksell Bone Nibbler, 5mm bite size -	
1	24cm/9 1/2" length	Leksell Bone Nibbler, 5mm bite size -	
1	MS1003-18	Jansen Bone Ronguer D/A, curved 5mm bite size - 18cm/7"	
1	length MS1027-21	Zielke Disc Ronguer, 5mm bite size - 21cm/8 1/4"	
1	length MS1027-21	Zielke Disc Ronguer, 5mm bite size - 21cm/8 1/4"	
Bayonet Bipolar Forceps, 1.5mm tips x 23cm/9" length			
1	MS1020-21	Bayonet Bipolar Forceps, 1.5mm tips x 23cm/9" length	LEVEL
1	70-01-92	Bayonet Bipolar Forceps, 1.5mm tips x 23cm/9" length	
Ball Tipped Probes x 2			
1	MS5250-13	Ball End Probe with 4mm tip - 23cm/9" length	LEVEL
1	MS5250-14	Ball End Probe with 6mm tip - 23cm/9" length	
Bone Curettes x 8			
1	MS8040-	Curette, straight, cup size 0 (2mm) - 27cm/10" length	LEVEL
1	27	Curette, straight, cup size 1 (3mm) - 27cm/10" length	
1	MS8050-	Curette, angled up, cup size 0 (2mm) - 27cm/10" length	
1	27	Curette, angled up, cup size 1 (3mm) - 27cm/10" length	
1	MS8140-	Bruns Curette, straight, cup size 2 (4mm) - 23cm/9"	
1	27	length Bruns Curette, straight, cup size 1 (5mm) -	
1	MS8150-	23cm/9" length Bruns Curette, angled up, cup size 2	
1	27	(4mm) - 23cm/9" length Bruns Curette, angled up, cup	
1	MS7561-	size 1 (5mm) - 23cm/9" length	
1	13	Cobb Elevators x 2	
Cobbs Elevator, 13mm width x 32cm/12 3/4"			
1	MS9101-	length Cobbs Elevator, 19mm width x 32cm/12	LEVEL
1	20	3/4" length	
Adson Hooks x 2			
1	MS9206-	Adson Sharp Hook 90°, 5mm tip - 20cm/8"	LEVEL
1	23	length Adson Blunt Hook 90°, 5mm tip -	
20cm/8" length			
Dissectors x 2			
1		MacDonald Dissector - 23cm/9" length	LEVEL
1		Watson Cheyne Dissector - 23cm/9" length	
1		Watson Cheyne Dissector - 23cm/9" length	

BAYONET MICRO INSTRUMENTS

Yasargil Bayonet Micro Forceps

- Flat handled
- Blunt tips



		Tip	
22.5cm/8 1/2"	MS2301 -	1mm	*illustrated
24cm/9 1/2"	22*	1mm	

Yasargil Bayonet Tumour Grasping Forceps

- Flat handled



Spoon shaped jaws

		Tip size	
22.5cm/8 1/2"	MS230 3 -	3mm	⊙
22.5cm/8 1/2"	22	5mm	⊙
	MS230 4 -		
	22		

Flat serrated jaws

		Tip size	
22.5cm/8 1/2"	MS2307 -		*illustrated
22.5cm/8 1/2"	22* MS230	3mm	
		5mm	⊙

Curette toothed jaws

		Tip	
22.5cm/8 1/2"	MS230 5 -22		⊙
22.5cm/8 1/2"	MS230 6 -22	3mm	⊙
		5mm	

Bayonet Micro Forceps

- Round bodied



		Tip	
21cm/8 1/4"	MS230 2 -21	1mm	*illustrated
23cm/9"	MS230 2 -	1mm	

Bayonet Tumour Grasping Forceps

- Round bodied
- Flat serrated jaws



Tip size

23cm/9"

MS230 9 -23

5mm



MEDASTE

BAYONET MICRO INSTRUMENTS

Yasargil Bayonet Micro Needle Holder

- Flat handled
- Delicate 1mm jaws



With Lock	Straight		Curved	Without Lock	Straight		Curved
23cm/9"	MS101 2-23	MS101 3-23		23cm/9"	MS111 2-23	MS111 3-23	

Bayonet Micro Needle Holder

- Round bodied
- Delicate 1mm jaws



With Lock	Straight		Curved	Without Lock	Straight		Curved
21cm/8 1/4"	MS101 0-21	MS1011 -21		21cm/8 1/4"	MS111 0-21	MS1111 -21	
23cm/9"	MS101 0-23	MS1011 -23		23cm/9"	MS111 0-23	MS1111 -23	

Yasargil Bayonet Micro Scissors

- Flat handled
- 22.5cm/8 3/4" length



Regular Blades
Blades



Straight
MS300 5 -22



Curved
MS300 6 -22

Vannas Fine



Straight
MS3007 -22



Curved
MS300 8 -22

STRAIGHT BIPOLAR FORCEPS

Straight Bipolar Forceps



16.5cm/6 1/2" length Tip size

70-01-52	0.7mm	Fine tip	—
70-01-51	1.0mm	Regular tip	—

19cm/7 1/2" length Tip size

70-01-72	0.7mm	Fine tip	—
70-01-71	1.0mm	Regular tip	—

26cm/10 1/4" length Tip size

70-02-80	2.0mm		—
----------	-------	--	---

Straight Bipolar Forceps Supergliss®

Non-Stick Tips



The material specially developed for SuperGliss® non-stick forceps prevents overheating of the tips during coagulation.

18.5cm/7 1/4" length Tip size

78-01-52MS	0.7mm	Fine tip	—
78-01-51MS	1.0mm	Regular tip	—

20cm/8 " length Tip size

78 01 72MS	0.7mm	Fine tip	—
78 01 71MS	1.0mm	Regular tip	—

BAYONET BIPOLAR FORCEPS

Bayonet Bipolar Forceps



19cm/7 1/2" length Tip size

70-01-83	0.7mm	—
70-01-81	1.0mm	—
70-01-82	2.0mm	—

23cm/9" length Tip size

70-01-91	0.7mm	—
70-01-92	1.2mm	—

25cm/9 3/4" length Tip size

70-02-91	0.7mm	—
70-02-92	1.2mm	—

Bayonet Bipolar Forceps SuperGliss®

Non-Stick Tips



20cm/8 1/2" length Tip size

78-21-83MS	0.7mm	—
78-21-81MS	1.0mm	—
78-21-84MS	1.2mm	—

The material specially developed for SuperGliss® non-stick forceps prevents overheating of the tips during coagulation.

23cm/9" length Tip size

78-01-91MS	0.7mm	—
78-01-98MS	1.0mm	—
78-01-92MS	1.2mm	—

25cm/9 3/4" length Tip size

78-02-91MS	0.7mm	—
78-02-98MS	1.0mm	—
78-02-92MS	1.2mm	—

BAYONET BIPOLAR FORCEPS

Bayonet Bipolar Forceps

- 22.5cm/8¾" length
- Non-stick tips
- Mallis 2 pin fitting



Tip Size

0.5m	10-5402 MS
m	10-5403 MS/0.7
0.7m	10-5403 MS
m	10-5403 MS
1.0m	10-5401 MS
m	10-5401 MS

MEDDASTEEL

BIPOLAR CABLES

Bipolar Lead

- Fitting Block End Forceps
- Banana Plug Valleylab Machine Fitting
- 4.5 metre length



37-01-35L

Bipolar Lead

- Fitting Block End Forceps
- Erbe BM780 Machine Fitting
- 4.5 metre length



37-01-38L

Bipolar Lead

- Fitting American 2-Pin Forceps
- Banana Plug Valleylab Machine Fitting
- 4.5 metre length



37-01-35S

MISC

Slim & Square Ended Wire Pliers

- 19cm/7 ½" length

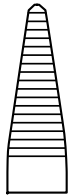

Slim Nose

MS7645 -19

Serrated jaw

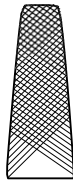

Square Ended*

MS7644 -19



*illustrated

Muller Claus Wire Cut

- Tungsten carbide edges

8-810E18

- 18cm/7" length*
- Cuts wire up to 2mm Ø



*illustrated

8-800E22

- 22cm/8 ¾" length
- Cuts wire up to 3mm Ø

Combined Wire Cutters & Pliers

- 18cm/7" length
- Suitable for wires up to 1.6mm Ø
- Parallel closing jaws

200-512 -185



MISC

- Max. cap 6.3mm

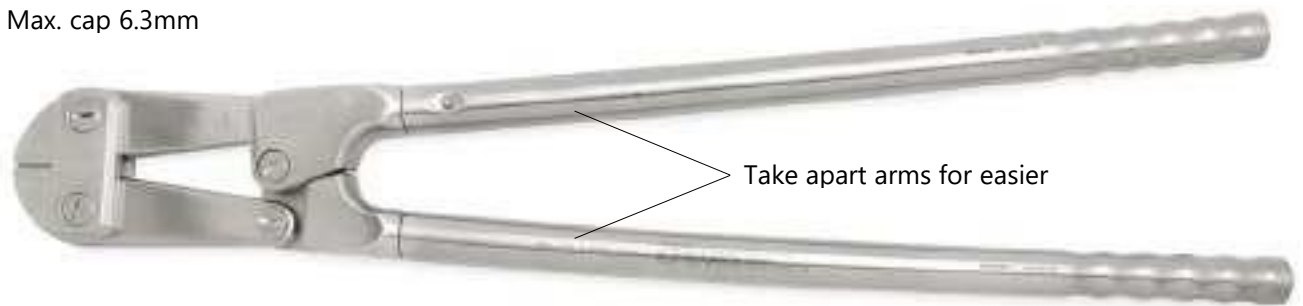

Bolt Cutters with dismantable arms

200-500-585

- Must be used in conjunction with a Rod Holder. Ordering code: 200-675-200

Orthopaedic Locking Plie

- Hardened jaws



Length

200-511-180	18cm/7"	Small
200-511-200	20cm/8"	Mediu
200-511-240	24cm/9 1/2"	m Large

Needle Nosed Locking Pliers



Code

200-514-220	22cm/8 3/4"	Small
200-515-250	25cm/9 3/4"	Mediu
200-516-300	30cm/11"	m Large

- A very useful instrument for orthopaedicsurgery allowing the surgeon to securely clamp on to wires and implants.

MISC

Measuring Caliper

- 25cm/10" length
- Measuring range 0 to 50mm

MS7334 -20



Castroviejo Caliper

- 7cm/2 ¾" length
- Measuring range 3mm to 25mm

MS7334 -10



Vernier Caliper

- 22.5cm/9" length
- Measuring range 15cm

MS7338 -00



Depth Gauge

- Measuring depth up to 50mm

MS7350-00



MISC

Depth Gauge

- Measuring depth up to 70mm

MS7370-00



Direct Reading Depth Gauge

- 23cm length
- Measuring depth up to 40mm

MS7333 -10



MEDAS

MISC

Frazier Suction Tube

- 17cm/6 ¾" length



	FG	Diamete
MS9041-17	6FG	2.0mm Ø
MS9042 -17	7FG	2.3mm Ø
MS9043 -17	8FG	2.7mm Ø
MS9044 -17	9FG	3.0mm Ø
MS9045 -17	10FG	3.3mm Ø
MS9046 -17	11FG	3.7mm Ø
MS9047-17	12FG	4.0mm Ø

Frazier Suction Tube

- 23cm/9" length



	FG	Diameter
MS9041-23	6FG	2.0mm Ø
MS9042-23	7FG	2.3mm Ø
MS9043-23	8FG	2.7mm Ø
MS9044-23	9FG	3.0mm Ø
MS9045-23	10FG	3.3mm Ø
MS9046-23	11FG	3.7mm Ø
MS9047-23	12FG	4.0mm Ø

Bayonet Dissecting Forceps

19cm/7 ½" Tip

MS9701-19	1mm
MS9702 -19	2mm

21cm/8 ½" Tip Size

MS9701-21	1mm
MS9702 -21	2mm



Size



MEDASTE

VOTRE APPRENTISSAGE, NOTRE DEVOIR

MEDASTE

Table des matières

Kerrison Laminectomy Punch.....	1
'Black Line' Kerrison Laminectomy Punch.....	2
Kerrison Laminectomy Punch with Bone Ejector	2
Titanium Kerrison Dismantable Punch.....	4
Long Anterior Kerrison Laminectomy Punch.....	5
Ferris-Smith Kerrison Laminectomy Punch.....	6
Intervertebral Disc Rongeur	7
Intervertebral Disc Rongeur	7
Intervertebral Disc Rongeur	7
Caspar Toothed Disc Rongeur.....	8
Schlesinger Toothed Rongeur.....	8
Williams Discectomy Rongeur.....	9
Williams Discectomy Rongeur longer pattern.....	9
'Pea Pod' Disc Rongeur	9
Beck Disc Rongeur.....	9
Munich Grasping Forceps	10
Decker Rongeur.....	10
Micro Disc Rongeur	11
Cushing Disc Rongeur	11
Ferris-Smith Disc Rongeur	12
Anterior Disc Rongeur	12
Lempert Bone Nibbler.....	13
Luer Bone Nibbler	13
Adson Bone Nibbler.....	13
Pennybacker Bone Nibbler.....	14
Northields Bone Nibbler	14
'Rat Toothed' Bone Nibbler	14
Zielke Intervertebral Rongeur.....	15
Matzen Intervertebral Rongeur.....	15
Beyer Bone Nibbler.....	15
Jansen Bone Nibbler.....	16
Marquardt Bone Nibbler.....	16
Smith-Peterson Bone Nibbler.....	16
Leksell Bone Nibbler.....	17
Stille-Luer Bone Nibbler.....	17
'Mr Blobby' Stille-Luer Bone Nibbler.....	17
BONE NIBBLERS.....	18
Echlin Duckbill Nibbler	18
Long Anterior Leksell Bone Nibbler.....	18
BONE CUTTERS.....	19
McIndoe Bone Cutters.....	19
Tudor Edwards/Vehmehren Costotome	19
OSTEOTOMES.....	20
Capener Osteotome	20
OSTEOTOMES.....	22
Scaglietti Straight Osteotome Set.....	22
Scaglietti Osteotomes.....	22
OSTEOTOMES.....	22
Mini-Stille Osteotome	22
Stille (Swedish) Osteotome.....	22
Hibbs Osteotome with thin blade.....	22
Smith Petersen Osteotome	22
MALLETS.....	23
Toffee Mallet.....	23
Heath Mallet	23

Mallet with Tufnol Handle.....	23
MALLETS.....	24
London Splint Mallet.....	24
Ombredanne Mallet.....	24
Mallet with Tufnol Handle.....	24
Tufnol Mallet.....	24
COBB ELEVATORS.....	25
Cobb Spinal Elevator.....	25
Harrington Cobb Spinal Elevator.....	25
Cobb Spinal Elevator Extra Long Handle.....	26
COBB ELEVATORS.....	26
Karl Cobb Elevator.....	26
Long Anterior Comfort Cobb Elevator.....	27
ELEVATORS.....	28
Adson Periosteal Elevator.....	28
Pennybacker Periosteal Elevator.....	28
Bone Raspatory with Tufnol Handle.....	28
Farabeuf Ruginé Elevator.....	28
Farabeuf Ruginé Elevator with Hollow Handle.....	29
ELEVATORS & GOUGES.....	28
Trethowan Bone Elevator.....	28
Bristow Periosteal Elevator.....	28
Zielke S-Shaped Gouge.....	28
Capener Lamina Gouge.....	28
DISSECTORS.....	29
Swedish Dissector.....	29
Howarth Elevator.....	29
MacDonald Elevator/Dissector.....	29
Watson Cheyne Dissector.....	29
Freers Elevator/Dissector.....	29
BONE GRAFT IMPACTORS.....	30
Cervical Bone Graft Impactor 9 0°Offset.....	30
Lumbar Bone Graft Impactor.....	30
Anterior Bone Graft Impactor.....	30
Caspar Bone Graft Holder and Impactor.....	31
BAYONET CERVICAL MICRO CURETTES.....	32
Cervical Micro Discectomy Curette Set.....	32
BAYONET CERVICAL MICRO CURETTES.....	32
Bayonet Cervical Curette.....	32
Container for 12 curettes.....	32
Lempert Curette.....	33
Bruns Curette.....	33
Tufnol Handle Micro Curette.....	34
Cobb Bone Curette.....	34
Comfort Handle Curette.....	34
Long Anterior Curette.....	34
Light-Grip Cervical Curettes.....	36
Light-Grip Lumbar Curettes.....	36
Cones Ring Curette.....	37
Karl Ring Curette.....	37
Zielke Curette.....	38
Volkmann Double Ended Curette.....	38

CASPAR CERVICAL DISTRACTION SET.....	39
Caspar Vertebral Body Distraction Set.....	39
Distraction Retractors.....	39
CASPAR CERVICAL DISTRACTION SET.....	40
Drill Guide.....	40
Screw Driver.....	40
Distraction Drill.....	40
Caspar Distraction Screws.....	41
LAMINA & VERTEBRAL SPREADERS.....	42
Cervical Vertebral Spreader.....	42
Cloward Cervical Spreader.....	42
Cloward Lamina Spreader.....	42
LAMINA & VERTEBRAL SPREADERS.....	42
Baby Inge Lamina Spreader.....	42
Inge Lamina Spreader.....	42
Scaglietti Lamina.....	42
Long Anterior Lamina Spreader.....	43
HOOKS & PROBES.....	44
Pedicule Probe.....	44
Pedicule Probe.....	44
Adson Dural Hook.....	44
Weary Blunt Nerve Hook.....	44
Crile Blunt Hook.....	44
Emmet Sharp Hook.....	44
Cushing Blunt Hook.....	45
HOOKS & PROBES.....	44
Adson Hook.....	44
Ball Tipped Probe.....	44
Ball Tipped Probe - Fine Pattern.....	44
Manipulation Hook.....	44
Blalock Blunt Hook.....	44
Caspar Exploration Hook Insulated.....	45
RHOTON MICRO DISSECTORS.....	46
Titanium Micro Round Dissectors.....	46
Titanium Micro Elevators.....	46
Titanium Micro Spatula Dissectors.....	46
Titanium Micro Hooks.....	47
RHOTON MICRO DISSECTORS.....	46
Titanium Micro Curettes.....	46
Titanium Micro Ball Dissectors.....	46
Dissector Sterilising Rack.....	46
NERVE ROOT RETRACTORS.....	47
Love Bayonet Nerve Root Retractor.....	47
Krayenbuhl Nerve Root Retractor.....	47
Caspar Bayonet Nerve Root Retractor.....	47
O'Connell Nerve Root Retractor.....	47
McCulloch Nerve Root Retractor.....	48
NERVE ROOT RETRACTORS.....	48
Shepperd Suction Nerve Root Retractor.....	48
Nerve Root Retractor.....	48
Hess Nerve Root Retractor.....	49
Nerve Root Retractor.....	49

HAND HELD RETRACTORS	50
Meyerding Retractor.....	50
Langenbeck Retractor.....	50
Volkman Catspaw Retractor.....	50
West's S/R Retractor.....	50
Weitlaner S/R Retractor.....	50
Mollison S/R Retractor - Child.....	50
Mollison S/R Retractor - Adult.....	50
Jefferson S/R Retractor.....	50
Irwin S/R Retractor.....	51
Travers S/R Retractor.....	51
Norfolk and Norwich S/R Retractor.....	51
Norfolk and Norwich Deeper Prongs S/R Retractor.....	51
Cones Self Retaining Retractor.....	52
Harvey Jackson Self Retaining Retractor.....	52
Beckman - Adson Retractor.....	52
Gelpi Laminectomy Retractor.....	53
Hardman Retractor.....	53
Viper Hinged Scoliosis Retractor.....	54
Viper Scoliosis Retractor.....	54
 McCULLOCH RETRACTOR SET	 55
Basic McCulloch Retractor Set.....	55
Extended McCulloch Retractor Set.....	55
 McCULLOCH RETRACTOR SET	 56
 MICRO DISCECTOMY SET	 57
McCulloch Style Instrument Set with Container.....	57
McCulloch Style Spinal Hook/Probe.....	58
 MICRO DISCECTOMY SET	 59
Cobb Spinal Elevator.....	59
Spinal Osteotome.....	59
'Hockey Stick' Chisel.....	59
Elevator Double Ended.....	59
McCulloch Suction Tube.....	59
McCulloch Nerve Root Retractor.....	60
 'BLACK BELT' CERVICAL RETRACTOR SET	 59
Basic 'Black Belt' Cervical Retractor System.....	59
Coloured Titanium.....	59
Extended 'Black Belt' Cervical Retractor System.....	59
 'BLACK BELT' CERVICAL RETRACTOR SET	 60
Blades.....	60
Blade Inserter.....	60
Clamp.....	60
Lumbar Micro Discectomy Attachments.....	61
 SUPER -SLIDE II LAMINECTOMY RETRACTOR SET	 61
Super-Slide Retractor Basic Set.....	61
Super-Slide Retractor Extended Set.....	61
Titanium Super-Slide Retractor Extended Set.....	61
 SUPER -SLIDE II LAMINECTOMY RETRACTOR SET	 62
Super-Slide Retractor Blades.....	62
Unilateral Blade Attachment.....	63

Standard 'Black Belt' Retractor with the addition of Micro Discectomy Attachments as detailed on page 56.

CASPAR MICRO LUMBAR DISCECTOMY RETRACTOR SET	63
Caspar Micro Discectomy Retractor	63
Complete Set	63
CASPAR MICRO LUMBAR DISCECTOMY RETRACTOR SET	64
Lateral Blades	64
Blade Ejector Forceps	64
Specula Range	64
Caspar Micro Discectomy Retractor Frame	64
PICCOLINO MINI LUMBAR RETRACTOR SET	65
Counter Retractor Frame	65
Lateral Blades Radiolucent	65
Piccolino Mini Lumbar Retractor Set	65
Complete Set	65
Specula	65
BLACK BELT MICRO DISCECTOMY RETRACTOR SET	66
Black Belt Micro Discectomy Retractor Set	66
Complete Set	66
LUMBAR SPINAL SET	67
Mercian introduce a new set of spinal instruments for lumbar spine surgery.	67
LUMBAR SPINAL SET	68
BAYONET MICRO INSTRUMENTS	69
Yasargil Bayonet Micro Forceps	69
Yasargil Bayonet Tumour Grasping Forceps	69
Bayonet Micro Forceps	69
Bayonet Tumour Grasping Forceps	70
BAYONET MICRO INSTRUMENTS	71
Yasargil Bayonet Micro Needle Holder	71
Bayonet Micro Needle Holder	71
Yasargil Bayonet Micro Scissors	71
STRAIGHT BIPOLAR FORCEPS	71
Straight Bipolar Forceps	71
Straight Bipolar Forceps Supergliss [®]	71
BAYONET BIPOLAR FORCEPS	72
Bayonet Bipolar Forceps	72
Bayonet Bipolar Forceps SuperGliss [®]	72
BAYONET BIPOLAR FORCEPS	73
Bayonet Bipolar Forceps	73
BIPOLAR CABLES	74
Bipolar Lead	74
Bipolar Lead	74
Bipolar Lead	74
Slim & Square Ended Wire Pliers	75
Muller Claus Wire Cutters	75
Combined Wire Cutters & Pliers	75
Bolt Cutters with dismantable arms	76
Orthopaedic Locking Pliers	76
Needle Nosed Locking Pliers	76
Measuring Caliper	77
Castroviejo Caliper	77

Depth Gauge	78
Depth Gauge	78
Direct Reading Depth Gauge	78
Frazier Suction Tube	79
Frazier Suction Tube	79
Bayonet Dissecting Forceps.....	79

Email: medastepro@gmail.com

